

HWDSB

2019 - 2020

Secondary School COURSE CALENDAR



curiosity • creativity • possibility

2019-2020 Course Calendar

The selection of courses and programs in secondary school depends on a partnership between students, parents/guardians, the school, and the community.

IMPORTANT NOTE TO PARENTS/GUARDIANS	1
EVALUATION OF STUDENT ACHIEVEMENT	2
ONTARIO STUDENT TRANSCRIPT (OST)	3
FULL DISCLOSURE	3
ONTARIO STUDENT RECORDS	3
PRIOR LEARNING ASSESSMENT AND RECOGNITION (PLAR)	3
ONTARIO CODE OF CONDUCT	4
SPECIAL EDUCATION	4
SPECIAL EDUCATION PLAN	4
SPECIAL EDUCATION ADVISORY COMMITTEE (SEAC)	4
GUIDANCE AND CAREER EDUCATION	5
ASSESSMENT CENTRE	5
PRIOR LEARNING EQUIVALENT CREDITS (PLEC)	6
SETTLEMENT WORKERS IN SCHOOLS – (SWIS) HAMILTON	6
INTERSCHOLASTIC ATHLETICS	6
OFSAA TRANSFER POLICY	6
ONTARIO SECONDARY SCHOOLS: GRADES 9-12, PROGRAM AND DIPLOMA REQUIREMENTS	7
THE CREDIT SYSTEM	7
DIPLOMA REQUIREMENTS	7
COMPULSORY CREDITS	7
CERTIFICATE REQUIREMENTS	8
CREDIT SUBSTITUTION	9
ADJUDICATION PROCESS	10
COURSE SELECTION INFORMATION	10
THE COURSE CODING SYSTEM	10
COURSE PREREQUISITES	11
TYPES OF COURSES	11
CHOOSING COURSES FOR GRADES 9 AND 10	11
COURSES BEYOND GRADE 10	12
PREREQUISITE CHARTS FOR THE ARTS, GRADE 9-12	14
PREREQUISITE CHART FOR BUSINESS STUDIES, GRADES 9-12	15
PREREQUISITE CHART FOR CANADIAN AND WORLD STUDIES, GRADES 9-12 - GEOGRAPHY	16
PREREQUISITE CHART FOR CANADIAN AND WORLD STUDIES, GRADES 9-12 - HISTORY	17
PREREQUISITE CHART FOR CANADIAN AND WORLD STUDIES, GRADES 10-12 – ECONOMICS, LAW AND POLITICS	18
PREREQUISITE CHART FOR CLASSICAL STUDIES AND INTERNATIONAL LANGUAGES	19
PREREQUISITE CHART FOR COMPUTER STUDIES, GRADES 10-12	19
PREREQUISITE CHART FOR COOPERATIVE EDUCATION COURSES	20
PREREQUISITE CHART FOR ENGLISH, GRADES 9-12	21
PATHWAYS TO ENGLISH	21
PREREQUISITE CHART FOR FRENCH AS A SECOND LANGUAGE, GRADES 9-12	22
PREREQUISITE CHART FOR GUIDANCE AND CAREER EDUCATION, GRADES 9-12	23
PREREQUISITE CHART FOR HEALTH AND PHYSICAL EDUCATION, GRADES 9-12	24
COURSES IN INDIGENOUS LANGUAGES, LEVELS 1-3	25
PREREQUISITE CHART FOR INDIGENOUS STUDIES	26
COURSES IN INTERDISCIPLINARY STUDIES, GRADES 11 AND 12	27
PREREQUISITE CHART FOR MATHEMATICS, GRADES 9-12	28

PREREQUISITE CHART FOR SCIENCE, GRADES 9-12	29
PREREQUISITE CHART FOR SOCIAL SCIENCES AND HUMANITIES	30
PREREQUISITE CHART FOR TECHNOLOGICAL EDUCATION, GRADES 9-12	31
DETAILED COURSE DESCRIPTIONS	34
SPECIALIZED PROGRAMS - DELIVERY OPTIONS	35
ONLINE LEARNING / E-LEARNING	35
SYSTEM ALTERNATIVE EDUCATION	35
SYSTEM SELF-PACED/SELF-DIRECTED LEARNING PROGRAM AT WESTMOUNT SECONDARY SCHOOL	35
S.H.A.E. (STRENGTHENING HAMILTON'S ABORIGINAL EDUCATION)	36
DUAL CREDIT PROGRAMS	37
EXPERIENTIAL LEARNING PROGRAMS	38
CO-OPERATIVE EDUCATION	38
SPECIALIZED "SYSTEM" EXPERIENTIAL LEARNING AND SCHOOL – WORK TRANSITION PROGRAMS	39
HEALTHCARE SUPPORT SERVICES PROGRAM	39
LIME RIDGE COMMUNITY CO-OP PROGRAM	40
"BUILDING CAREERS FROM THE GROUND UP" RESIDENTIAL CONSTRUCTION PROGRAM	41
CANADIAN FORCES ARMY RESERVE CO-OP PROGRAM	41
THE ONTARIO PUBLIC SERVICE (OPS) LEARN AND WORK PROGRAM COOP PROGRAM	42
ART SMART PERFORMING ARTS CO-OP PROGRAM	42
OYAP - ONTARIO YOUTH APPRENTICESHIP PROGRAM	43
SPECIALIZED PROGRAMS (SCHOOL-BASED PROGRAMS)	47
SPECIALIST HIGH SKILLS MAJOR (SHSM)	47
SPECIALIZED LEARNING PROGRAMS IN THE HWDSB	48
ARTS AND CULTURE	49
SCIENCE AND TECHNOLOGY	50
SOCIAL JUSTICE	50
INTERNATIONAL BACCALAUREATE DIPLOMA PROGRAMME	51
FRENCH IMMERSION PROGRAM AT SHERWOOD AND WESTDALE SECONDARY	52

Important Note to Parents/Guardians

While the Secondary School program is based on a four-year program of study, please note that although there is no Ministry of Education requirement stating that students must finish their secondary school program in four years, in 2013-2014 the Ministry of Education put in place a 34 credit threshold. Hamilton-Wentworth District School Board encourages students to plan their high school pathway in such a way that will maximize achievement, post-secondary opportunities and personal satisfaction. Many students may find that four-and-a-half or five years of secondary school are what is required to meet their achievement, post-secondary preparation, and personal satisfaction goals.

Following secondary school, students may proceed beyond 34 credits through:

- E-learning;
- Night School;
- Summer School;
- Independent Learning Centres; and/or
- Adult Day School.

Please note, the 34 credit threshold does not apply:

- If the student has an Individual Education Plan (IEP);
- If the student is not enrolled in secondary school; nor
- To English as a Second Language (E.S.L.) core language courses and/or English Literacy Development (E.L.D.) core language courses (eg. ESL/ELDAO, ESL/ELDBO, ESL/ELDCO, ESL/ELDDO, ESL/ELDEO).

Additional information on the 34 Credit Threshold can be found at www.edu.gov.on.ca/eng/students/faqs.html.

This Course Calendar will assist students and parents/guardians in making those important course and program selections. It is important to emphasize, however, that the Course Calendar is not the only source of information. Teachers, counselors and administrators can provide valuable assistance in all matters related to course selection, program and career planning. Students and parents/guardians are encouraged to seek advice and assistance from these professionals.

Not all courses listed in this calendar are available at every school. School option sheets indicate what courses are offered at each school in each program area. Students and parents/guardians should note that course offerings are subject to change.

EVALUATION OF STUDENT ACHIEVEMENT

Students will be evaluated in a variety of ways, in order to give an accurate picture of what they have learned, and how they have progressed. Assessment and evaluation will be based on achievement of the overall curriculum expectations and separately on the development of the learning skills and work habits as outlined in all courses of study.

An evaluation outline for each course in which the student is enrolled is provided at the beginning of the semester and copies of these are available to parents/guardians upon request.

Parents/Guardians will continue to be informed of their child's progress through a regular schedule of report cards. The Provincial Report Card will be used to provide information regarding academic progress and development of the learning skills and work habits, in a consistent way throughout all schools. Parents/Guardians are encouraged to contact their school by phone or email for information or advice on the progress of their child at any time during the school year.

ONTARIO STUDENT TRANSCRIPT (OST)

The Ontario Student Transcript (OST) provides an official and consistent summary of student achievement in Ontario secondary school credit courses. As students earn secondary school credits, their personal achievement in each course is recorded on this form as a percentage grade.

After the student leaves school, the Ontario Student Transcript will be kept on file and a copy will be provided to the student upon graduation or leaving school. The record is maintained in case he/she ever needs an official report of marks, such as might be required by a college, university or employer. Marks will not be released by the school without the permission of the student or of a parent/guardian if the student is under 18.

FULL DISCLOSURE

The following procedures will be used upon withdrawal from a course and repetition of a course.

Withdrawal From a Course

Grades 9 and 10

Withdrawals from Grade 9 and 10 courses are not recorded on the OST. Only successfully completed courses are recorded on the OST.

Grades 11 and 12

If a student withdraws from a course after five instructional days following the issue of the mid-semester report card, the withdrawal is recorded on the OST by entering a “W” in the “Credit” column. The student’s percentage grade at the time of the withdrawal is recorded in the “Percentage Grade” column. Withdrawals prior to that time are not recorded.

Repetition of a Course

Students who repeat a course that they have previously completed successfully can earn only one credit for the course. However, in Grades 11 and 12, each attempt and percentage grade obtained is recorded on the OST, and an “R” is entered in the “Credit” column for the repeated course(s) along with the lower percentage grade.

For more information regarding these policies, see the Student Services personnel in your school.

ONTARIO STUDENT RECORDS

An Ontario Student Record (OSR) file is maintained for each student. This record is a basic element in the process of monitoring a student’s progress through school. Once a student’s progress and achievement have been measured and evaluated, they are recorded in the OSR. Other data recorded include date of birth, Social Insurance Number, Ontario Education Number (OEN), schools attended, and names of parents/guardians.

A student and his/her parents/guardian may have access to the student’s OSR. For more information about this, please contact the Student Services department at your school.

PRIOR LEARNING ASSESSMENT AND RECOGNITION (PLAR)

Prior Learning Assessment and Recognition (PLAR) for Day School Secondary Students is the formal evaluation and credit-granting process whereby students may obtain credits for prior learning. Prior learning includes the knowledge and skills that students have acquired, in both formal and informal ways, outside Ontario secondary school classrooms. Students may have their knowledge and skills evaluated against the expectations outlined in provincial curriculum policy documents in order to earn credits toward their secondary school diploma.

PLAR procedures are carried out under the direction of the school principal who grants credits. The PLAR process involves two components: Challenge or Equivalency.

i) Challenge: a student's prior learning is assessed for the purpose of granting credit for a course developed from a provincial curriculum policy document. This type of PLAR is available for grades 10, 11 and 12 courses to students registered in an HWDSB secondary school. A maximum of 4 credits may be granted through this process. No more than 2 credits may be granted in one discipline.

ii) Equivalency: for students who are transferring from home schooling, a non-inspected private school, or a school outside of Ontario, principals may grant equivalency credits for placement purposes based on their evaluation of the student's previous learning. Parents should contact the Assessment Centre for an appointment to meet with a teacher to discuss equivalency credits prior to the student starting in their new secondary school.

For additional information on Prior Learning Assessment and Recognition (PLAR), please connect with the Student Services Team at your local high-school.

ONTARIO CODE OF CONDUCT

The Ontario Code of Conduct sets clear provincial standards of behaviour and specifies the mandatory consequences for student actions that do not comply with the standards. The provincial standards of behaviour apply not only to students, but also to all individuals involved in the publicly funded school system – parents/guardians, volunteers, teachers, and other staff members – whether they are on school property, on school buses, or at school-authorized events or activities.

In addition to the Ontario Code of Conduct, each school is responsible for developing a School Code of Conduct that is in line with the provincial code under its Safe Schools Policy. The School Code is to be developed and reviewed regularly with input from school councils, students, staff, parents/guardians, volunteers, and the community.

A copy of the Parent's Guide to the Ontario Code of Conduct (2018) can be accessed on the ministry website at: <http://www.edu.gov.on.ca/eng/safeschools/CodeOfConductEN.pdf>

SPECIAL EDUCATION

Secondary school students with special learning needs may require special services or programs to benefit fully from their school experience. The Special Education programs and services of the Board are outlined in the pamphlet entitled "Working Together: A Guide to Special Education/Student Services". This guide is available in all school offices, Learning Resource rooms, and on the Board website at:

<https://www.hwdsb.on.ca/wp-content/uploads/2012/07/Parent-Handbook-English.pdf>

For more information, please contact your School Administrator or Learning Resource teacher.

SPECIAL EDUCATION PLAN

Hamilton-Wentworth District School Board's Special Education Plan (2018-19) is available on the Board's website at: <http://www.hwdsb.on.ca/wp-content/uploads/2018/07/HWDSB-Special-Education-Plan-2018-19.pdf>

SPECIAL EDUCATION ADVISORY COMMITTEE (SEAC)

The Special Education Advisory Committee is a standing committee of the Board. Its membership includes representatives of various parent associations, trustees, and other related community agencies, as well as elementary

and secondary principal and teacher groups. The committee advises the Board on matters relating to Special Education. The representatives advocate for special needs children and youth regardless of their exceptionality and can be of assistance to all parents/guardians. SEAC contact information is available in “Working Together: A Guide to Special Education and Student Services” from your School Administrator or Learning Resource Teacher, or through the link: <https://www.hwdsb.on.ca/wp-content/uploads/2012/07/Parent-Handbook-English.pdf>

GUIDANCE AND CAREER EDUCATION

Secondary school students must make a wide range of decisions about school, and their personal, social and career choices. From adjusting to Grade 9 to designing a pathway through secondary school, the Student Services Department of each secondary school helps students with these decisions. Once a student reaches secondary school, an educational plan is a useful way to decide on the courses to take after the introductory grade nine program. Such a plan will take into account the student’s career plans including post-secondary education, while ensuring that the requirements for the Ontario Secondary School Diploma (OSSD) are met. All students will complete and revisit their Individual Pathway Plan (IPP) while in high school. In addition, a vital and integral part of secondary school is the guidance and career education program. The content of the program is organized into three areas of learning: student development (i.e. the development of habits and skills necessary for learning), interpersonal development (i.e. the development of knowledge and skills needed in getting along with others), and career development (i.e. the development of knowledge and skills needed for setting short and long term goals and for planning the future).

ASSESSMENT CENTRE

Hamilton-Wentworth District School Board Assessment Centre is located at Plaza Level Suite 606 of the Robert Thomson Building at 110 King Street West, Hamilton. The operation of the Centre is under the direction of the Principal of International Education Services. Contact information can be found at: <http://www.hwdsb.on.ca/community/admissions/>

The Assessment Centre provides a variety of services for students new to the board and those re-registering with us. For newcomer students and their families, the Assessment Centre provides English language and mathematics assessments to assist students and schools in accessing appropriate resources and making the best course placement decisions. It is important to note that the assessment is not a formal placement test. The initial assessment process includes orientation to the Ontario Secondary School Diploma requirements and pathways options, as well as supports and services available through Settlement Workers in Schools (SWIS).

English as a Second Language (ESL) assessments are conducted for elementary and secondary school students. Elementary school students are referred to the Assessment Centre by their home schools, whereas secondary school students must make an appointment at the Assessment Centre prior to registering for school (see contact information above).

Before registering in a secondary school, students meeting ANY of the following requirements must have their English language skills assessed at the Assessment Centre:

- New to Canada, entering the Ontario school system for the first time, and whose first language is not English or is a variety of English not used for instruction in Ontario’s schools
- Re-entering the Ontario school system following an absence of more than one year
- From a French language school in Canada
- International (Visa) students
- Transferring from another Canadian school board (outside Ontario) to Hamilton-Wentworth District School Board and who are English Language Learners still requiring ESL or ELD support

Following the assessment, an appropriate program placement is recommended (e.g., ESL, ELD, ENG) and an appointment is made for the student to register at the school.

PRIOR LEARNING EQUIVALENT CREDITS (PLEC)

Students who are eligible for Prior Learning Equivalent Credits through the Prior Learning and Recognition (PLAR) process (see page 2) are those who have transferred to Hamilton-Wentworth District School Board secondary schools from:

- outside Canada;
- other provinces;
- non-inspected private schools;
- home schooling environments.

Assessment of prior learning is initiated at the HWDSB Assessment Centre, however, the granting of Prior Learning Equivalent Credits is the responsibility of the principal of the school that the student attends.

SETTLEMENT WORKERS IN SCHOOLS – (SWIS) Hamilton

In partnership with YMCA Immigrant Settlement Services of Hamilton, the Assessment Centre also has a Newcomer Information Specialist on site to assist families with settlement needs and link newcomer students and their parents/guardians with Settlement-Workers-In-Schools (SWIS), located in various schools throughout the community. SWIS workers strive to:

- Link newcomer students and their parents/guardians with school resources and advocate on behalf of newcomers; and
- Provide information and connect newcomer students and families to services, programs and community resources.

If you have further questions about how the SWIS program can assist you and your family, please contact the SWIS manager, YMCA Immigrant Settlement Services of Hamilton, at 905-526-8452.

INTERSCHOLASTIC ATHLETICS

HWDSB offers lots of opportunities for inter-school competition in fall, winter and the spring sports seasons. Each year, teams and sports offered are dependent on student sign-up and the number of coaches available. Sports range from traditional sports like: Basketball, Field Hockey, Football, Volleyball and Soccer; to Cricket, Cross Country Running, Touch Football and Water Polo (visit www.hwdsb.on.ca/athletics for more sport offerings). Any student wishing to participate in inter-school athletic competition should check with their individual schools for more specific requirements on how to participate in extra-curricular athletics. Further information can be obtained from the school Principal and the Head of Physical and Health Education.

OFSAA TRANSFER POLICY

Any student who transfers to or from a Hamilton-Wentworth District School Board secondary school is subject to the requirements of the OFSAA Transfer Policy. The Transfer Policy offers a number of exceptions to meet some circumstances of students changing schools; however students and parents/guardians should be aware that all transfer students are ineligible for interschool competition until declared eligible through the transfer process. Generally if you have attended another school in the last 12 months you are considered a transfer student. Further information can be

obtained from the school Principal and the Head of Physical and Health Education – Male or Female. It is unethical and unacceptable for students to transfer schools for the sole purpose of interscholastic competition.

ONTARIO SECONDARY SCHOOLS: GRADES 9-12, PROGRAM AND DIPLOMA REQUIREMENTS

Students in Grades 9 -12 are subject to the diploma requirements of the Ministry of Education, as described in the section for these grades. More details can be found in **Ontario Schools: Kindergarten to Grade 12, Policy and Program Requirements, 2011**, copies of which are available from local secondary schools and on the Ministry of Education website at: http://www.edu.gov.on.ca/eng/document/policy/os/onschools_2016e.pdf.

Great care has been taken in editing this document but errors do occur and provincial policies do change. The most authoritative source for course descriptions, course prerequisites and graduation requirements is the Ministry of Education website.

THE CREDIT SYSTEM

A credit is granted in recognition of the successful completion of a course that has been scheduled for a minimum of 110 hours. Normally, students in Grades 9-12 will be able to earn eight in each year towards the 30 credits they will require to obtain the Ontario Secondary School Diploma (OSSD).

DIPLOMA REQUIREMENTS

The following requirements must be successfully completed in order to obtain an OSSD:

- 30 credits including 18 compulsory credits and 12 optional credits;
- 40 hours of community involvement; and
- Successful completion of the provincial literacy requirement (Ontario Secondary School Literacy Test).

COMPULSORY CREDITS

- 4 English (1 credit per grade)
- 3 Mathematics (1 at the Senior Level)
- 2 Science
- 1 French
- 1 Canadian Geography (Grade 9)
- 1 Canadian History (Grade 10)
- 1 Arts credit (any of Visual Arts, Music, Drama, Dance or Media Arts)
- 1 Health and Physical Education
- 0.5 credit in Civics
- 0.5 credit in Career Studies

Group 1 – one additional credit in English OR French OR Native Languages OR Classical and International Languages OR Social Sciences and Humanities OR Canadian and World Studies OR Guidance and Career Education OR Cooperative Education

Group 2 – one additional credit in Health and Physical Education OR the Arts OR Business Studies OR Cooperative Education OR French

Group 3 – one additional credit in Computer Studies (Grade 10-12) OR French OR Science (Grade 11 or 12) OR Technological Education (Grade 9-12) OR Cooperative Education

A maximum of two of the three additional compulsory credit requirements for groups 1, 2, and 3 may be met with credits earned through cooperative education. A maximum of two additional credits in French may be used; one of these may be used to meet the compulsory credit requirement for group 1 and the other may be used to meet the compulsory credit requirements for groups 2 or 3.

OPTIONAL OR ELECTIVE COURSES

Students must complete a minimum of 12 elective credits selected from those available and those of specific interest to the student and his or her individual goals for career and future educational programs. These will be selected with the assistance of parents/guardians, counselors, teachers and administrators.

COMMUNITY INVOLVEMENT

As a part of the requirement for graduation, all students entering Grade 9 must complete a minimum of 40 hours of community involvement during their four years of secondary school in order to obtain an Ontario Secondary School Diploma (OSSD). This diploma requirement is designed to encourage civic responsibility, promote community values, support students' career explorations, develop their interests and skills, and reinforce the importance of volunteering. It will encourage students to develop an understanding of the various roles they can play in their communities, help them to develop a greater sense of belonging within those communities, and recognize the positive effects they can have in them. Community involvement must occur outside of scheduled instructional time that is part of the normal school day and may include a broad range of unpaid activities.

Students will select one or more community involvement activities in consultation with their parents/guardian. Selection of activities must take into account the age, maturity and ability of the student, the location and environment of the proposed activity and the need for any special training, equipment and preparation. The safety of students is paramount. Students with special needs as well as other selected students may have Individual Education Plans (IEPs) that outline accommodations and/or modifications related to this component.

An Information Guide is available for students, parents and community members/organizations wishing to sponsor a "Community Involvement" activity. This manual may be obtained from your local community secondary school.

Students may begin accumulation of Community Involvement Hours in the summer before they enter Grade 9. More information is available on the Board's website at:

<http://www.hwdsb.on.ca/secondary/graduation-information/diploma-requirements/cih/>

CERTIFICATE REQUIREMENTS

The Ontario Secondary School Certificate

The Ontario Secondary School Certificate (OSSC) will be granted on request to students who leave school before earning the Ontario Secondary School Diploma, provided that they have earned a minimum of 14 credits distributed as follows:

- Compulsory Credits (total of 7)
- 2 credits in English
- 1 credit in Mathematics
- 1 credit in Science
- 1 credit in Canadian History OR Canadian Geography
- 1 credit in Health and Physical Education
- 1 credit in the Arts OR Technological Education

The Certificate Of Accomplishment

Students who leave school before fulfilling the requirements for the OSSD or the OSSC may be granted a Certificate of Accomplishment. The Certificate of Accomplishment may be a useful means of recognizing achievement for students who plan to take certain vocational programs or other kinds of further training, or who plan to find employment after leaving school.

CREDIT SUBSTITUTION

In order to ensure that all students can qualify for the OSSD or the OSSC, principals may substitute among the compulsory credits as follows:

- Up to three compulsory credits may be replaced by additional courses from the remainder of those listed as compulsory;
- A maximum of one credit earned for a learning strategies course may be used through substitution to meet a compulsory credit requirement; or
- Up to three of the Grade 9, 10 and 11 English compulsory credits may be replaced by English as a Second Language (ESL) or English Literacy Development (ELD) credits.

Parent/Guardian approval of such a substitution shall be provided in writing. Each substitution shall be noted on the Ontario Student Transcript.

Students who qualify under this substitute credit arrangement are those whose educational interests, in the opinion of their parents or guardians, principals, and supervisory officers, are best served by such substitution.

ONTARIO SECONDARY SCHOOL LITERACY REQUIREMENT

Students entering secondary school are required to successfully complete the Ontario Secondary School Literacy Test (OSSLT) based on language and communications expectations of the curriculum up to and including Grade 9. This test has been designed by the provincial Education Quality and Accountability Office (EQAO). Successful achievement of this test will be recorded on the Ontario Student Transcript. Remedial help will be provided by the school. Students will be able to retake the test if they are unsuccessful.

Ontario Secondary School Literacy Course (OLC401)

The Ontario Secondary School Literacy Course (OSSLC) is a full-credit Grade 12 course that will be offered as part of the English program in Ontario secondary schools.

This course is designed to help students acquire and demonstrate the cross-curricular literacy skills that are evaluated by the Ontario Secondary School Literacy Test (OSSLT). Students who complete the course successfully will meet the provincial literacy requirement for graduation. Students will read a variety of informational, narrative, and graphic texts and will produce a variety of forms of writing, including summaries, information paragraphs, opinion pieces, and news reports. Students will also maintain and manage a portfolio containing a record of their reading experiences and samples of their writing.

Eligibility requirement: Students who have been eligible to write the OSSLT **who have been unsuccessful at least once** are eligible to take the course. (Students who have already met the literacy requirement for graduation may be eligible to take the course under special circumstances, at the discretion of the principal).

Please note: Though OLC401 can be counted as a compulsory Grade 12 English credit for the OSSD, credit in the course does not fulfill the Grade 12 English requirement for post-secondary admission.

ADJUDICATION PROCESS

School boards may establish adjudication panels at the end of the school year to provide certain students with an additional opportunity to meet the literacy requirement for graduation. These students include those who would be eligible but through no fault of their own have been unable to take advantage of normal opportunities to write the OSSLT and/or been unable to enroll in or complete the OSSLC, owing to unforeseen circumstances. Students who receive special education programs or services and have an IEP that documents required accommodations but, owing to unforeseen circumstances, did not have access to these accommodations when taking the OSSLT, may also be eligible for adjudication. More information can be obtained from your school principal.

COURSE SELECTION INFORMATION

The following information applies to all courses offered in the secondary schools of Hamilton-Wentworth District School Board:

- Students under the age of 18 require parent/guardian approval for all decisions on course choices. Students who are 18 years of age or older MAY accept responsibility for their own course choices.
- Most courses offered in Hamilton-Wentworth District School Board schools are open to both male and female students.
- Courses of study for each course offered in a school are maintained in the school office and are available for examination by parents/guardians upon request.
- The courses offered by the secondary schools of Hamilton-Wentworth District School Board have been developed according to the requirements of the Ministry of Education.

THE COURSE CODING SYSTEM

Courses are identified by three letters followed by a number and a letter. For example, “ENG2P” means English for Grade 10 students, an applied course.

The first character indicates the subject area:

- A** Arts
- B** Business
- C** Canadian and World Studies
- E** English
- F** French
- G** Guidance and Career Education
- H** Social Sciences and the Humanities
- I** Computer Studies
- L** Classical and International Languages
- M** Mathematics
- N** First Nations, Metis and Inuit Studies
- P** Health and Physical Education
- S** Science
- T** Technological Studies

The next two characters differentiate between subjects within the subject area:

- **CGC** means “Issues in Canadian Geography”, while **CHC** means “Canadian History Since World War I”

The first number indicates the grade level of the course:

- 1** Grade 9
- 2** Grade 10

- 3 Grade 11
- 4 Grade 12

The letter following the first number indicates the type of course and the course pathway:

- D Academic
- L Locally Developed Compulsory Credit
- O Open
- P Applied
- C College
- E Workplace
- M University/College
- U University
- T College Delivered Dual Credit

The course codes in this calendar show the credit value as the sixth character. See your school's Student Services Department for more information.

COURSE PREREQUISITES

Some courses extend or build upon the knowledge and skill developed in another course. The course that gives the required background and training is a prerequisite of the course that follows.

If a course has a prerequisite, it will be noted at the end of the course description. The prerequisite course **must be successfully completed** before the student may register in the next course. Course descriptions and Course Flow Charts which include prerequisites are detailed in this document, and are taken from the MInistry document: [The Ontario Curriculum, Grades 9-12: Course Descriptions and Prerequisites \(2018\)](#). Students and parents/guardians should consult these charts to determine student's appropriate course selection and pathway.

TYPES OF COURSES

CHOOSING COURSES FOR GRADES 9 AND 10

Students in Grade 8 and 9 will choose courses of one or more types: Academic, Applied, Locally Developed Compulsory Credit, and Open. They will make their choices primarily on the basis of their goals, interests, learning preferences, needs and achievement.

The following is a brief description of the types of courses that are available in the different subjects, taken from Ontario Schools: Policy and Program Requirements (2016). More information can be found for each course within your school's option sheet and course descriptions.

Academic courses develop students' knowledge and skills through the study of theory and abstract problems. These courses focus on the essential concepts of a subject and explore related concepts as well. They incorporate practical applications as appropriate.

Applied courses focus on the essential concepts of a subject and develop students' knowledge and skills through practical applications and concrete examples. Familiar situations are used to illustrate ideas, and students are given more opportunities to experience hands-on applications of the concepts and theories they study.

Open courses, which comprise a set of expectations that are appropriate for all students, are designed to broaden students' knowledge and skills in subjects that reflect their interests and prepare them for active and rewarding

participation in society. They are not designed with the specific requirements of university, college, or the workplace in mind.

Locally Developed Compulsory Credit courses focus on literacy, mathematical literacy, essential job skills and essential concepts. These courses are available in English, French, Mathematics, Science and History only. Students may be placed in these courses specially designed for students who have been working on expectations that are below the course grade level. Students who successfully complete these courses may choose the Grade 9 Applied, Academic, or the Workplace course in the same subject in Grade 11.

ENRICHED PROGRAM - Grade 9 Mathematics & English

In these courses, the assessments, evaluations and curriculum expectations are comparable to Academic courses. Class material is presented in a way that encourages students to explore and investigate learning beyond the curriculum. These courses are well-suited for students who may be passionate about the subject, are identified as gifted, plan to pursue the International Baccalaureate stream in grades 11 and 12, or enjoy learning through inquiry to deeply understand big ideas. Credits granted are the same as for Academic English and Mathematics courses.

EMPOWER COURSE

All secondary schools will offer the Empower™ Reading Program to students. Successful students earn one credit as ELS2O. Empower™ Reading is an intensive reading program developed by Hospital for Sick Children researchers. Empower™ Reading will be delivered in 75-minute blocks, five times a week for a total of 80 lessons. The time commitment is an essential part of the program so it is vital that your child attends regularly. Teachers assess the progress of students in the Empower™ Reading program on a regular basis using a variety of tools. HWDSB also offers Empower Reading to primary level students in all schools and several schools with junior and intermediate level classes.

COURSES BEYOND GRADE 10

In grades 11 and 12, courses prepare students for their post-secondary destinations including: university preparation courses, university/college preparation courses, college preparation courses, and workplace preparation courses. Open courses are also offered in Grades 11 and 12.

The following is a brief description of the types of courses that are available in the different subjects, taken from Ontario Schools: Policy and Program Requirements (2016). More information can be found for each course within your school's option sheet and course descriptions.

College preparation courses are designed to equip students with the knowledge and skills they need to meet the entrance requirements for most college programs or for admission to specific apprenticeship or other training programs.

University preparation courses are designed to equip students with the knowledge and skills they need to meet the entrance requirements for university programs.

University/college preparation courses are designed to equip students with the knowledge and skills they need to meet the entrance requirements for specific programs offered at universities and colleges.

Workplace preparation courses are designed to equip students with the knowledge and skills they need to meet the expectations of employers, if they plan to enter the workforce directly after graduation, or the requirements for admission to certain apprenticeship or other training programs.

Open courses, which comprise a set of expectations that are appropriate for all students, are designed to broaden students' knowledge and skills in subjects that reflect their interests and prepare them for active and rewarding

participation in society. They are not designed with the specific requirements of university, college, or the workplace in mind.

Each high school offers its own option sheet, which indicates which courses are offered in each program area, as not all courses listed in this calendar are available at every school. Students and parents should note that course offerings are subject to change.

Schools can choose to offer a focus in some courses. Focus courses are listed at the end of the subject area under which they may be offered. The course description and prerequisite for a focus course are the same as the core “parent” course at that level. Not all focus courses are available at every school.

Prerequisite Charts for the Arts, Grade 9-12

This chart maps out all the courses in the discipline and shows the links between courses and the possible prerequisites for them. It does not attempt to depict all possible movements from course to course.

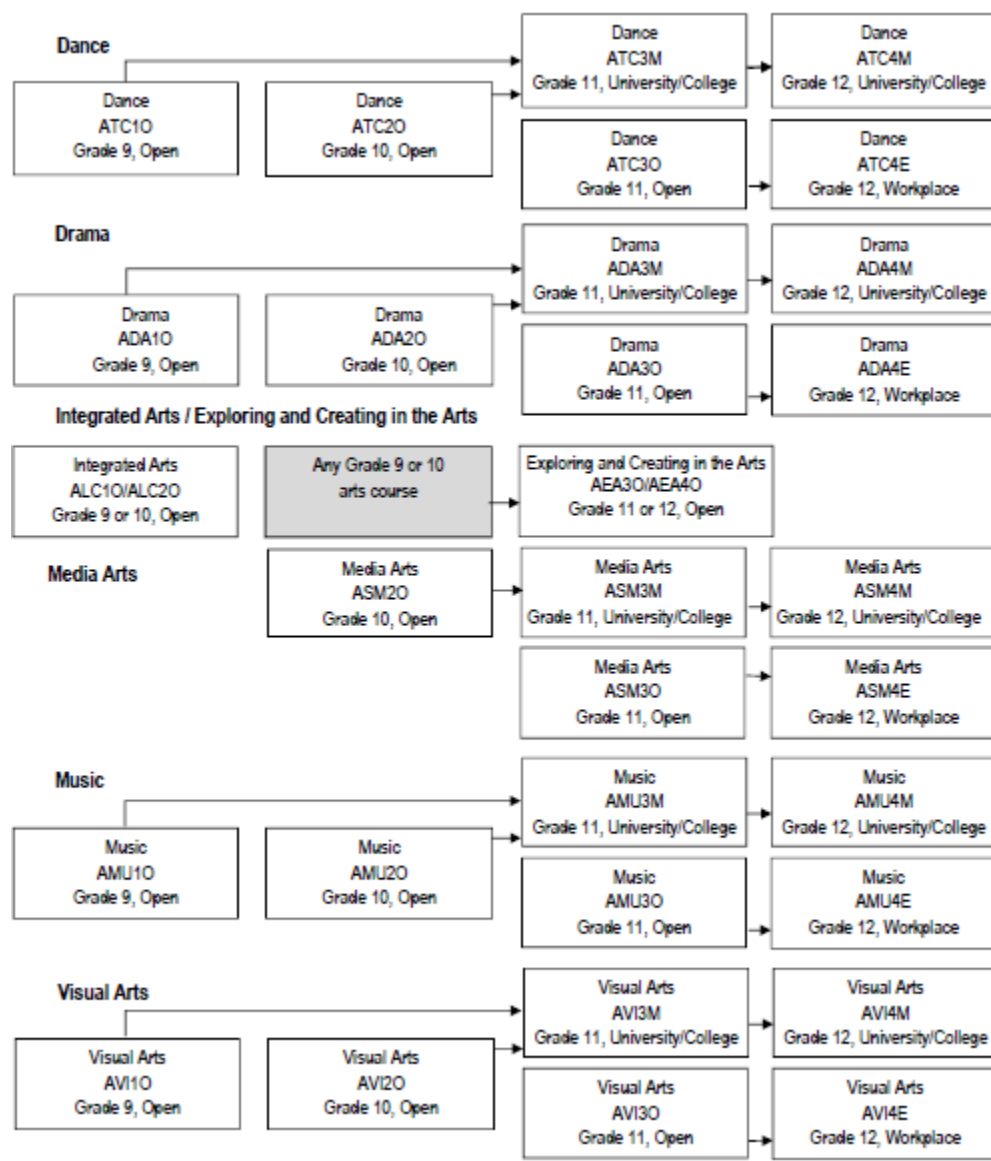

COURSE CODES FOR FOCUS COURSES IN THE ARTS, GRADES 9 TO 12 (2018) CAN BE FOUND ON PAGES 147-148 IN THE FOLLOWING DOCUMENT:

[THE ONTARIO CURRICULUM, GRADES 9 TO 12: COURSE DESCRIPTIONS AND PREREQUISITES, 2018](#)

Prerequisite Chart for Business Studies, Grades 9-12

This chart maps out all the courses in the discipline and shows the links between courses and the possible prerequisites for them. It does not attempt to depict all possible movements from course to course.

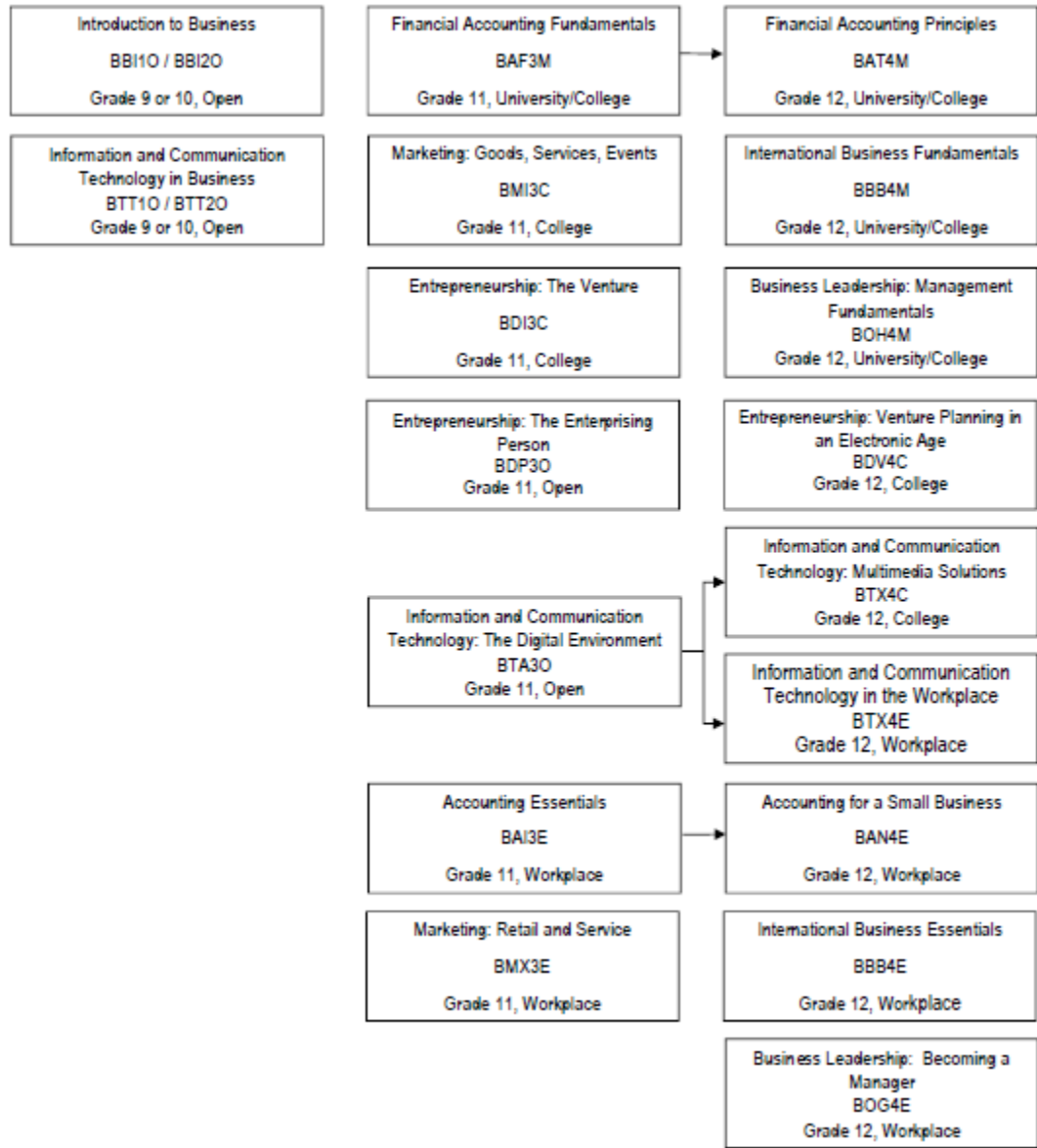

Prerequisite Chart for Canadian and World Studies, Grades 9-12 - Geography

This chart maps out all the courses in the discipline and shows the links between courses and the possible prerequisites for them. It does not attempt to depict all possible movements from course to course.

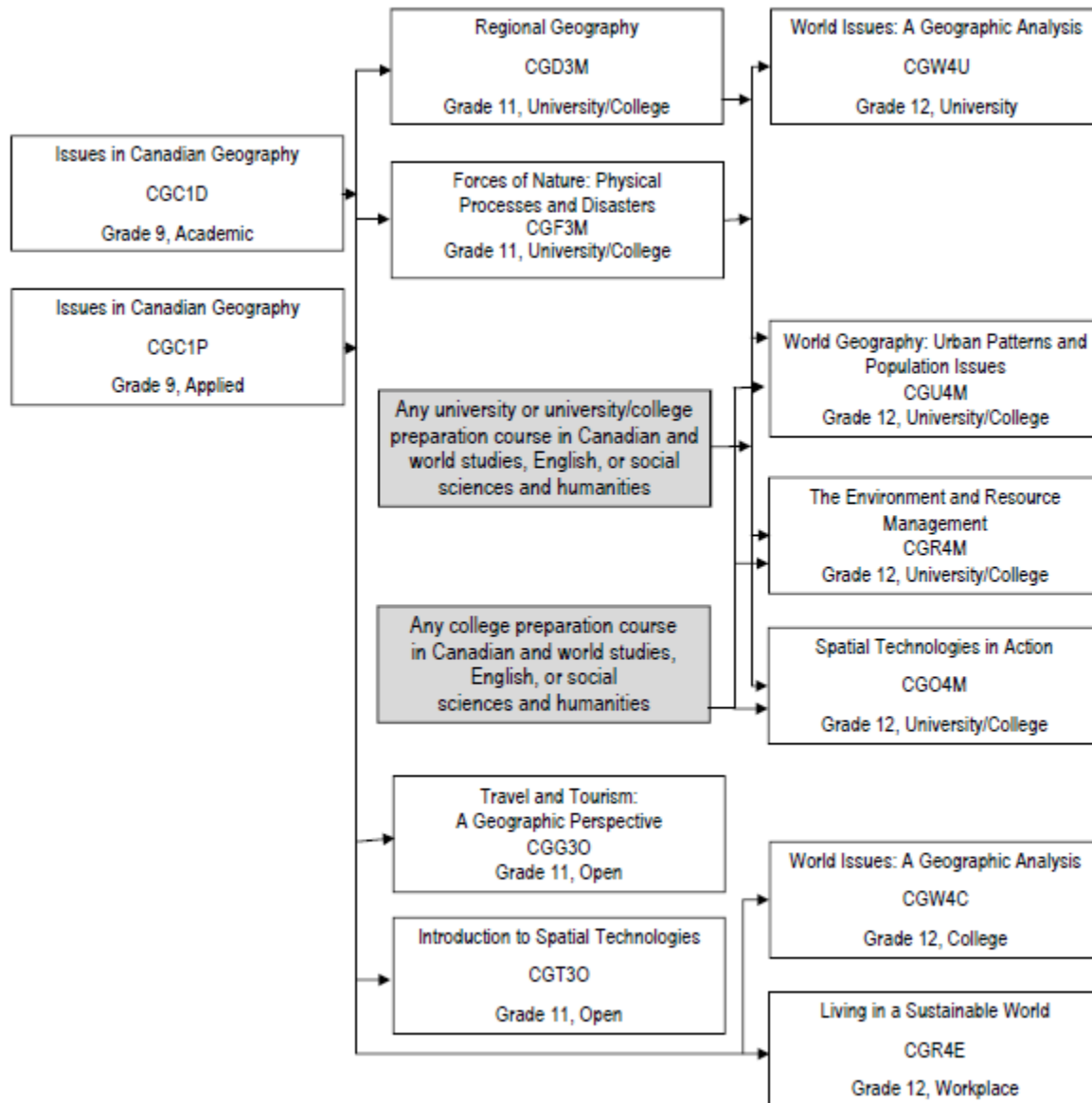

Prerequisite Chart for Canadian and World Studies, Grades 9-12 - History

This chart maps out all the courses in history and shows the links between courses and the possible prerequisites for them. It does not attempt to depict all possible movements from course to course. Note: Dashed lines represent locally developed compulsory credit courses (LDCC), which are not outlined in the curriculum document.

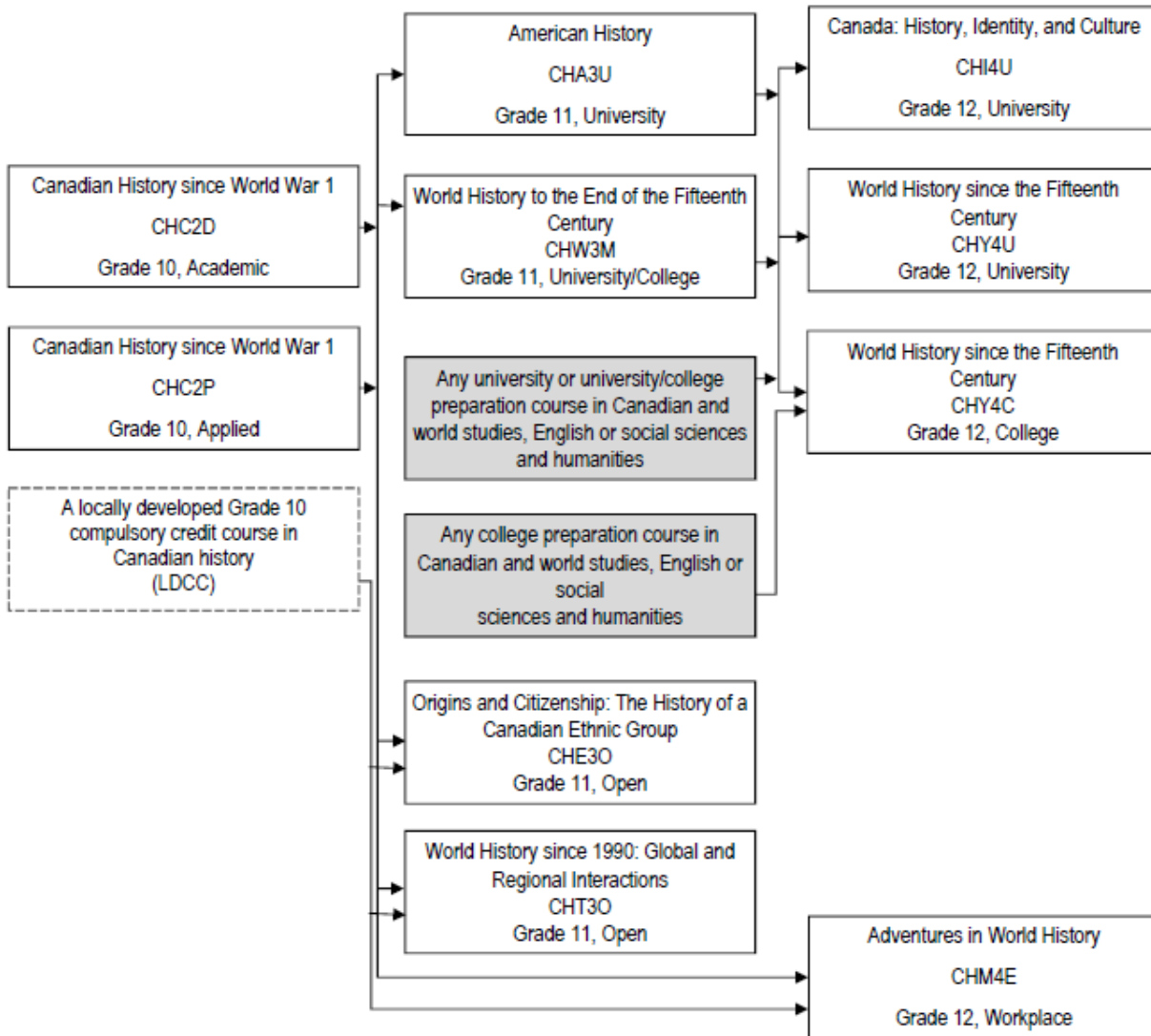

Prerequisite Chart for Canadian and World Studies, Grades 10-12 – Economics, Law and Politics

This chart maps out all the courses in economics, law, and politics, and shows the links between courses and the possible prerequisites for them. It does not attempt to depict all possible movements from course to course. Note: Dotted lines represent locally developed compulsory credit courses (LDCC), which are not outlined in the curriculum document.

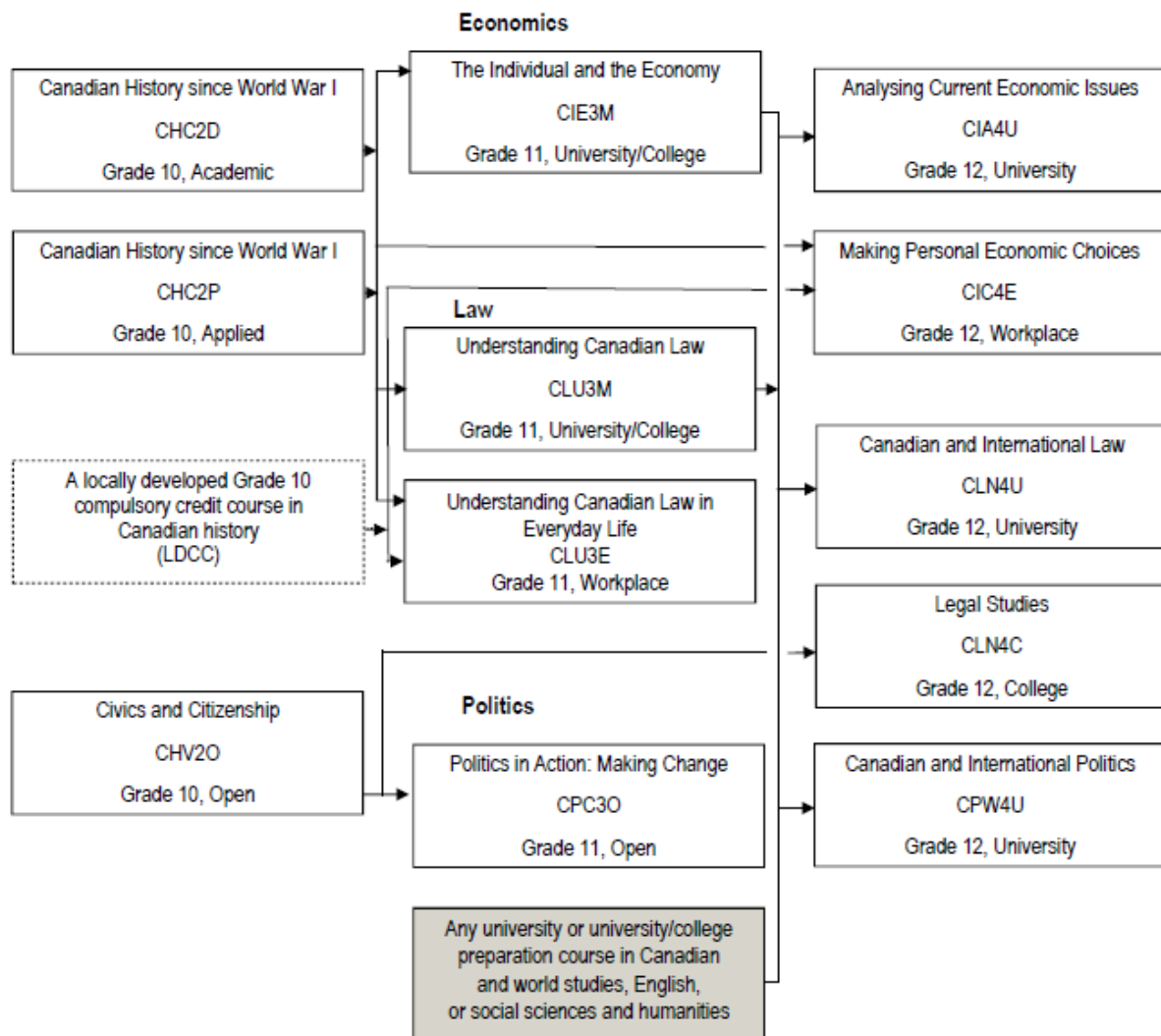

Prerequisite Chart for Classical studies and International Languages

This chart maps out all the courses in economics, law, and politics, and shows the links between courses and the possible prerequisites for them. It does not attempt to depict all possible movements from course to course. Note: Dotted lines represent locally developed compulsory credit courses (LDCC), which are not outlined in the curriculum document.

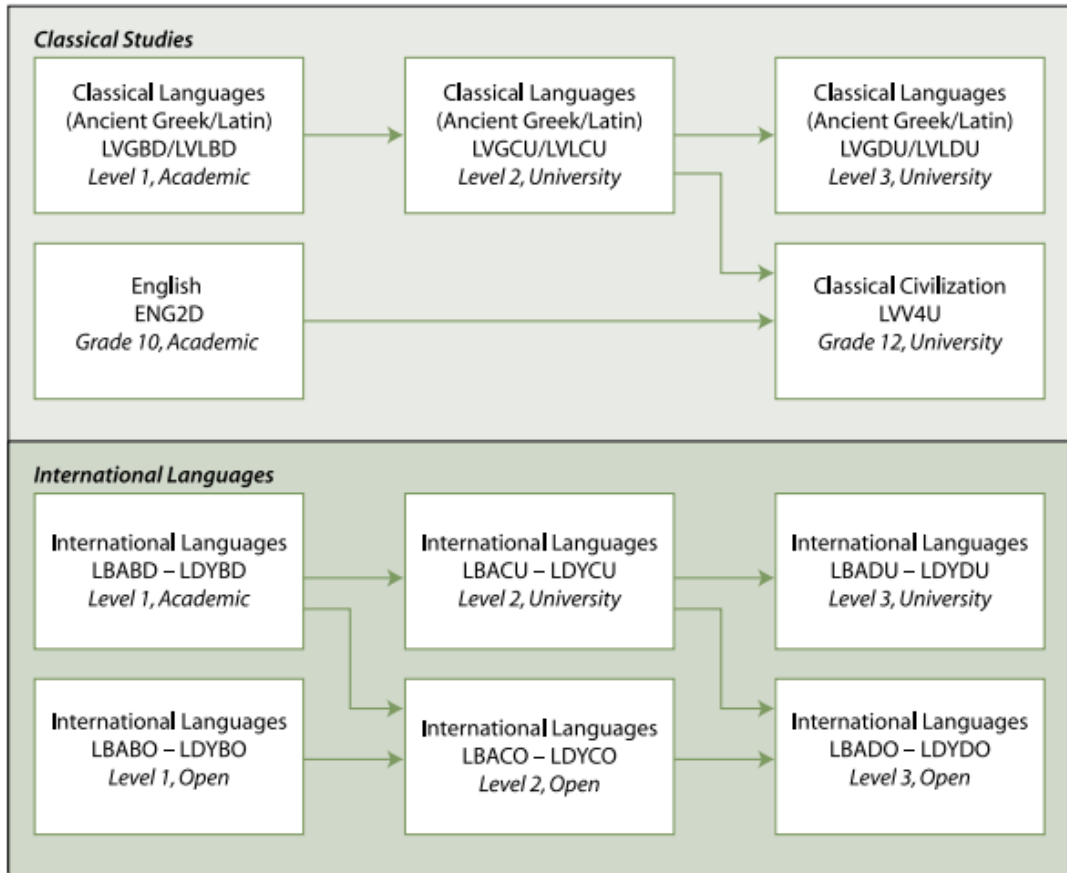

Course Codes for International Languages as described in the curriculum policy documents Classical and International Languages - Grades 9 and 10 (1999) and Classical Studies and International Languages - Grades 11 and 12 (2000) can be found on pages 149-150 in the following document: [The Ontario Curriculum, Grades 9 to 12: Course Descriptions and Prerequisites, 2018](#)

Prerequisite Chart for Computer Studies, Grades 10-12

This chart maps out all the courses in the discipline and shows the links between courses and the possible prerequisites for them. It does not attempt to depict all possible movements from course to course.

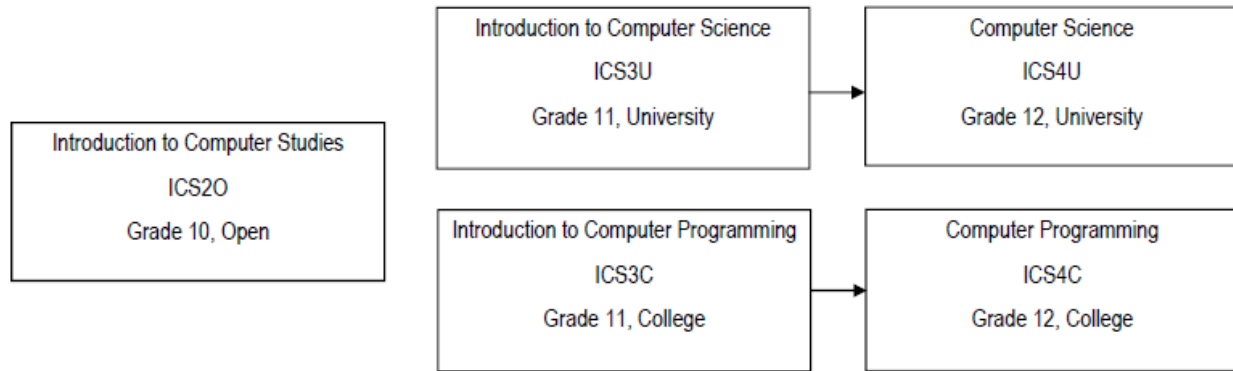

Prerequisite Chart for Cooperative Education Courses

This chart maps out all the courses in the discipline and shows the links between courses and the possible prerequisites for them. It does not attempt to depict all possible movements from course to course.

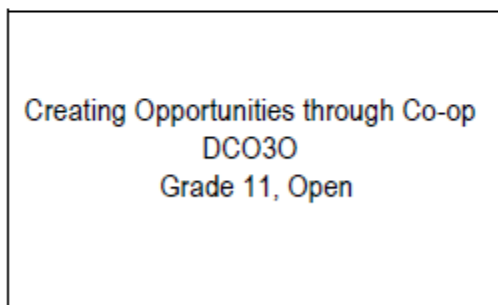
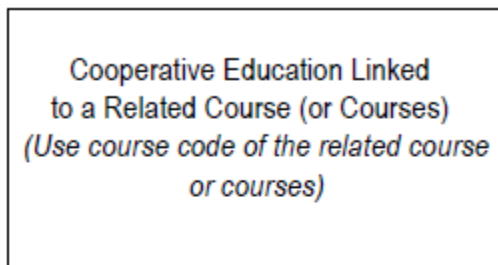

Prerequisite Chart for English, Grades 9-12

These charts map out all the courses in the discipline and show the links between courses and the possible prerequisites for them. They do not attempt to depict all possible movements from course to course. Note: Dotted lines represent locally developed compulsory credit courses (LDCC), which are not outlined in the curriculum document. Dashed lines represent courses that are not outlined in this curriculum.

Pathways to English

The chart below shows how most English language learners may progress through their ESL and/or ELD courses and into mainstream English courses. Not all students will follow this sequence exactly, and individual students may vary in the rate at which they progress through the levels. Note: The dashed lines represent courses that are not outlined in this curriculum.

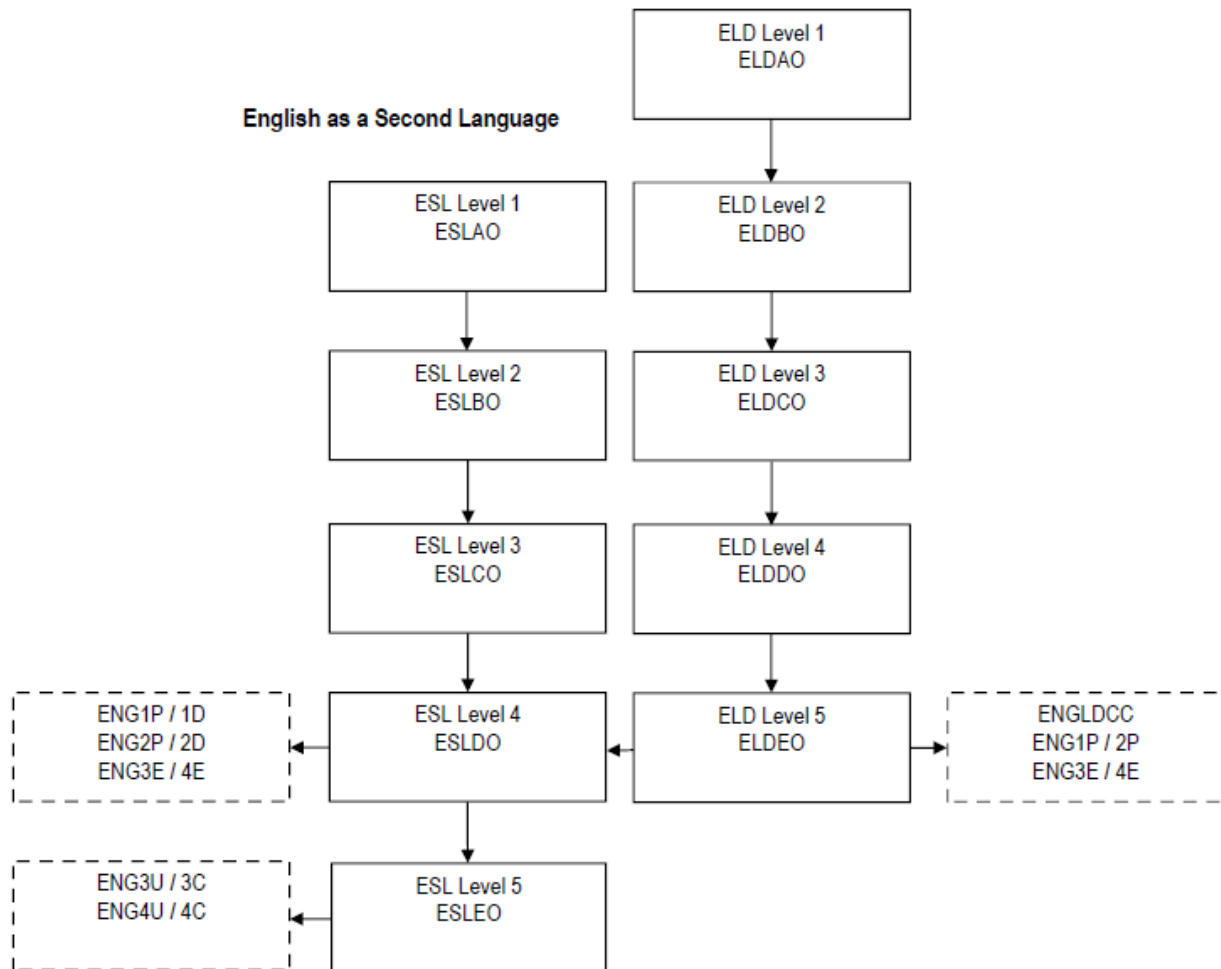

Prerequisite Chart for French as a Second Language, Grades 9-12

These charts map out all of the courses in each program in FSL and show the links between courses and the possible prerequisites for them. They do not attempt to depict all possible movements from course to course

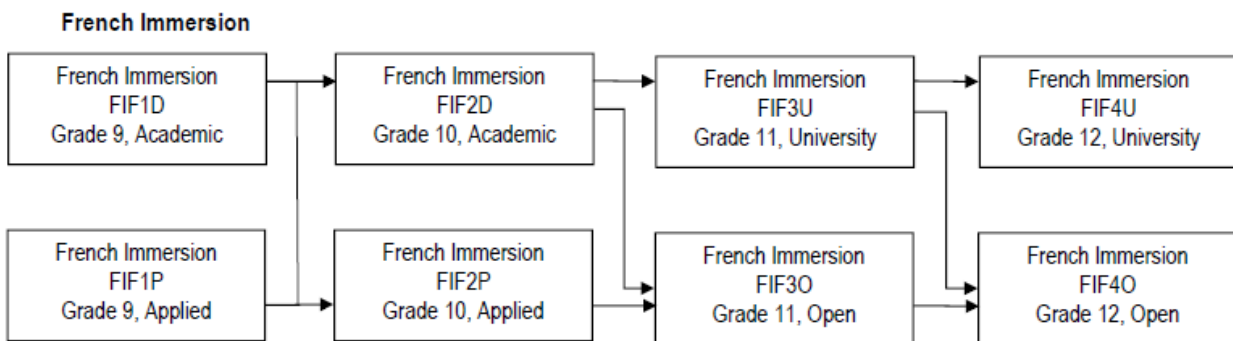
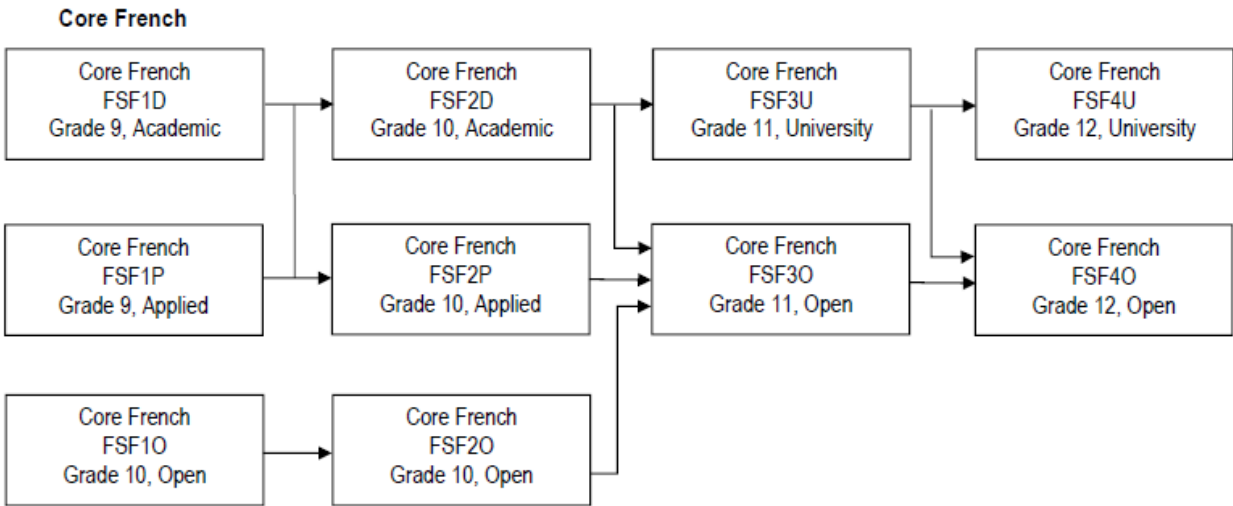

Prerequisite Chart for Guidance and Career Education, Grades 9-12

This chart maps out all the courses in the discipline and shows the links between courses and the possible prerequisites for them. It does not attempt to depict all possible movements from course to course.

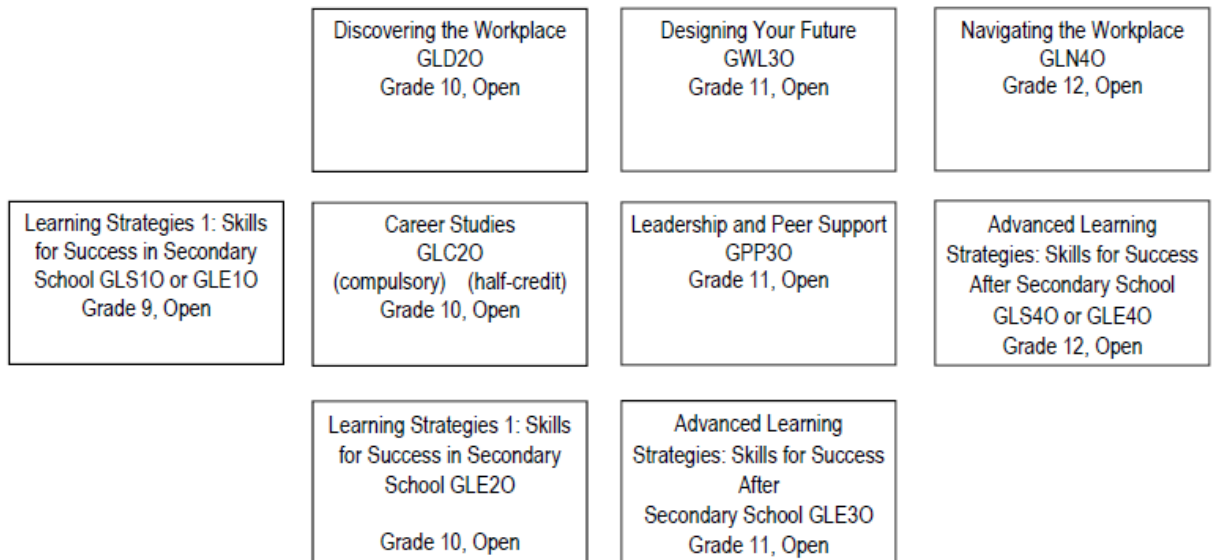

Prerequisite Chart for Health and Physical Education, Grades 9-12

This chart maps out all the courses in the discipline and shows the links between courses and the possible prerequisites for them. It does not attempt to depict all possible movements from course to course.

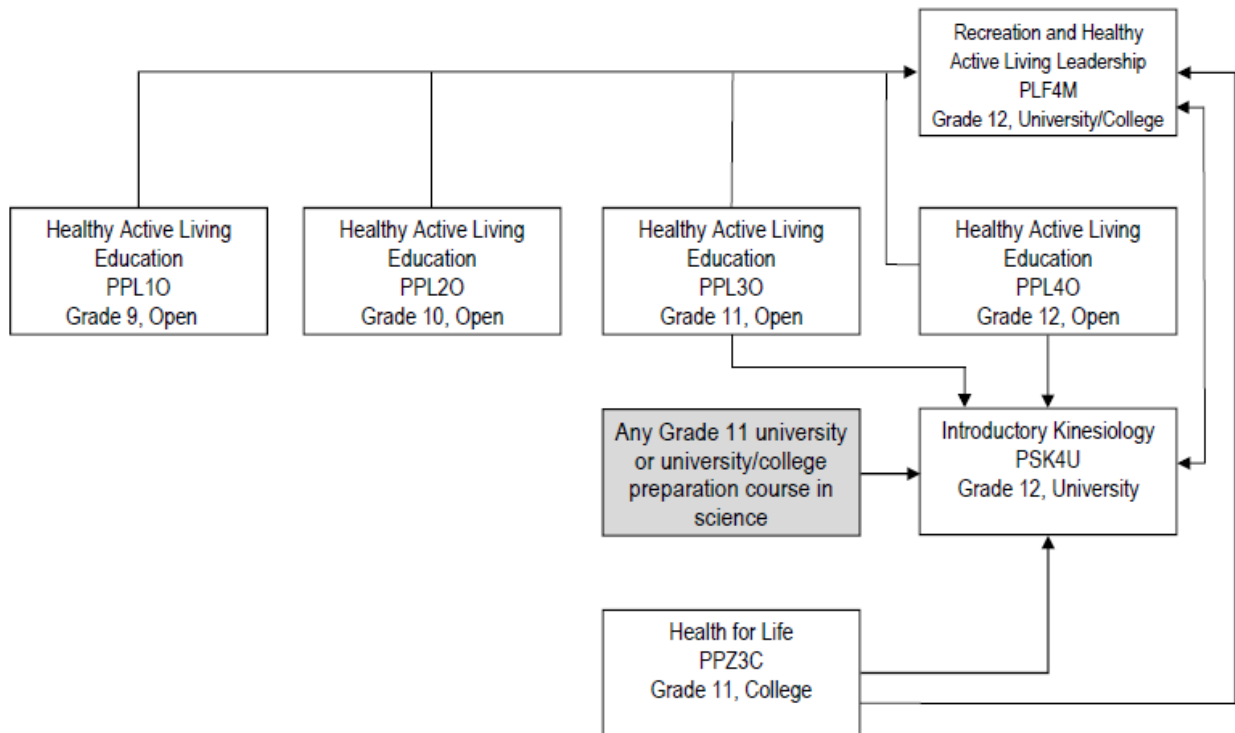

Courses in Indigenous Languages, Levels 1-3

Level	Course Name	Course Type	Course Code	Credit Value	Prerequisites
1	Native Languages (NL1)	Open	LNAAO–LNOAO	1	
2	Native Languages (NL2)	Open	LNABO–LNOBO	1	At least four years of study of a Native language in elementary school, successful completion of NL1, or demonstrated proficiency
3	Native Languages (NL3)	Open	LNACO–LNOCO	1	Successful completion of NL2 or demonstrated proficiency

A Note About Credits. Students may earn more than one credit per grade in Indigenous languages by studying more than one Indigenous language.

Courses offered in Indigenous languages may be offered as half-courses, earning half-credits. Half-credit courses, which require a minimum of fifty-five hours of scheduled instructional time, must adhere to the following conditions:

- Courses offered as half-credit courses must include a selection of learning expectations from all strands and must reflect the balance among strands that characterizes the full course
- A course that is a prerequisite for another course may be offered as two half-courses, but the student must successfully complete both parts of the course to claim the prerequisite.
- The title of each half-credit course must include the designation Part 1 or Part 2. A half-credit (0.5) will be recorded in the credit-value column of both the report card and the Ontario Student Transcript. Students are not required to complete both Part 1 and Part 2 unless the course is a prerequisite for another course that the student wants to take.

Prerequisite Chart for Indigenous Studies

This chart maps out all the courses in the discipline and show the links between courses and the possible prerequisites for them. It does not attempt to depict all possible movements from course to course. Note: Dashed lines represent courses that are not in the curriculum document. Note: Dotted lines represent locally developed compulsory credit courses (LDCC), which are not outlined in the document.

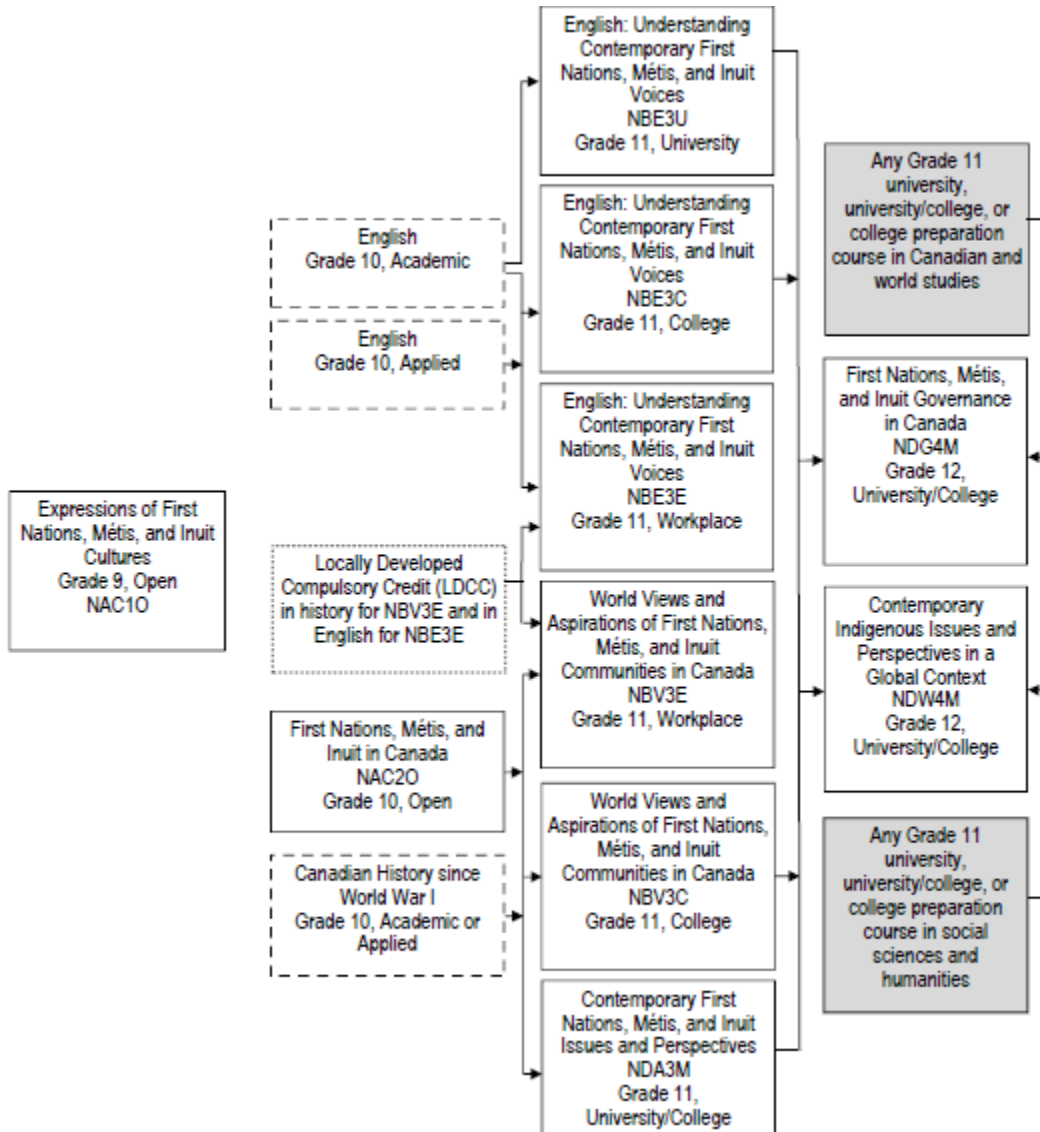

Courses in Interdisciplinary Studies, Grades 11 and 12

The accompanying chart outlines the interdisciplinary studies courses that can be offered in Grades 11 and 12. Interdisciplinary studies courses are designated as “open” or “university preparation” depending on which designation is the most appropriate as a basis for combining other courses and/or expectations. Course content, instructional strategies, and assessment procedures should be designed to meet the grade-level expectations for each course. For an interdisciplinary studies package of courses, students must satisfy the prerequisite for each of the courses in the package. Note that single-credit courses are designated with the course code beginning with “IDC”; multiple-credit packages of courses are designated with the course code beginning with “IDP”.

Interdisciplinary Studies (2002)

Courses in Interdisciplinary Studies, Grades 11 to 12

Grade	Course Name	Course Type	Course Code	Prerequisite
11	Interdisciplinary Studies	Open	IDC30	None
11	Interdisciplinary Studies	Open	IDP30	The prerequisite for each of the courses in the package
12	Interdisciplinary Studies	University	IDC4U	Any university or university/ college preparation course
12	Interdisciplinary Studies	University	IDP4U	The prerequisite for each of the courses in the package
12	Interdisciplinary Studies	Open	IDC40	None
12	Interdisciplinary Studies	Open	IDP40	The prerequisite for each of the courses in the package

Prerequisite Chart for Mathematics, Grades 9-12

This chart maps out all the courses in the discipline and shows the links between courses and the possible prerequisites for them. It does not attempt to depict all possible movements from course to course. T represents a transfer course. Dotted lines represent locally developed compulsory credit courses (LDCC courses are not outlined in the curriculum document.)

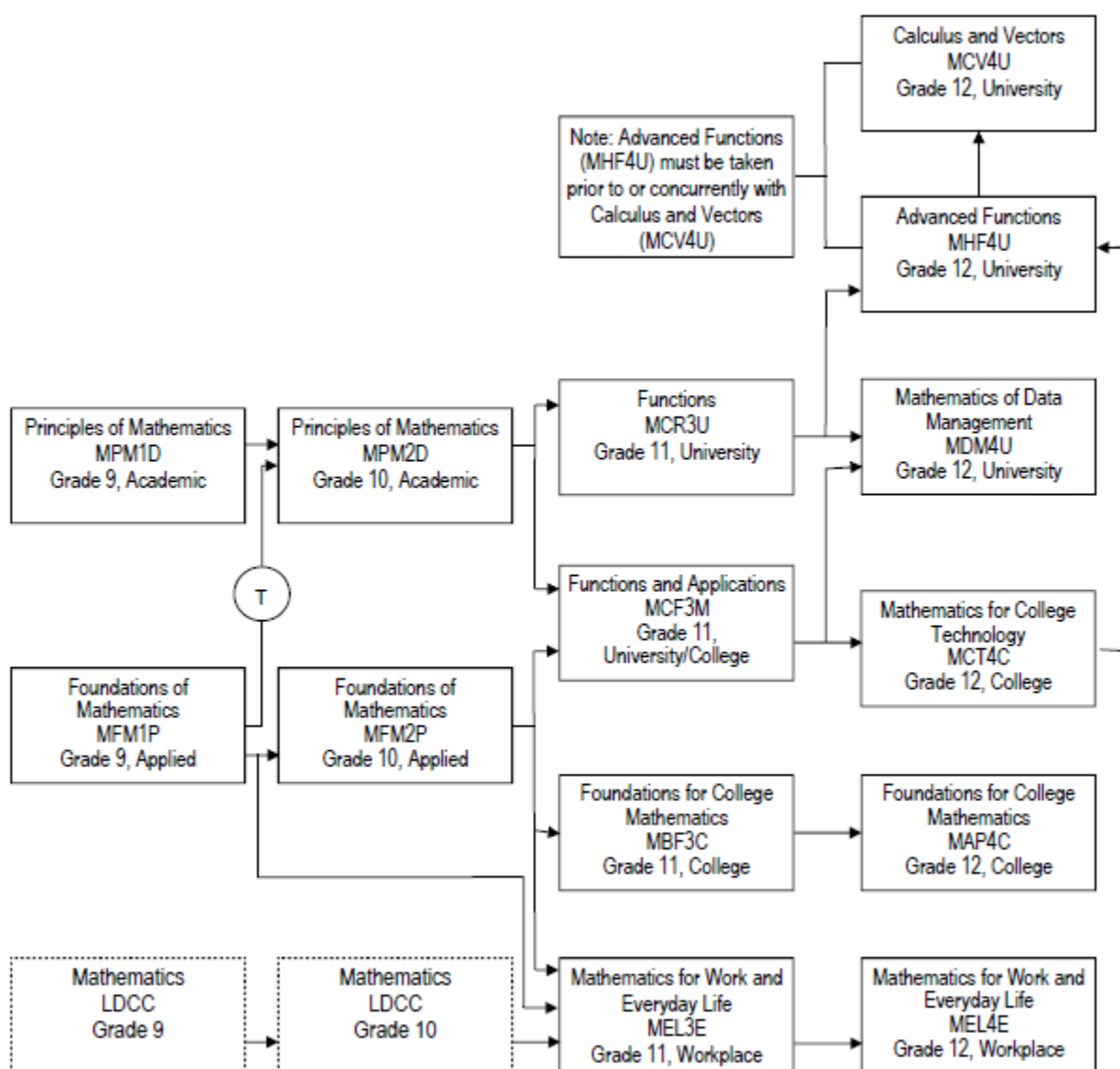

Prerequisite Chart for Science, Grades 9-12

This chart maps out all the courses in the discipline and shows the links between courses and the possible prerequisites for them. It does not attempt to depict all possible movements from course to course. Note: Dotted lines represent locally developed compulsory credit courses (LDCC), which are not outlined in the curriculum document.

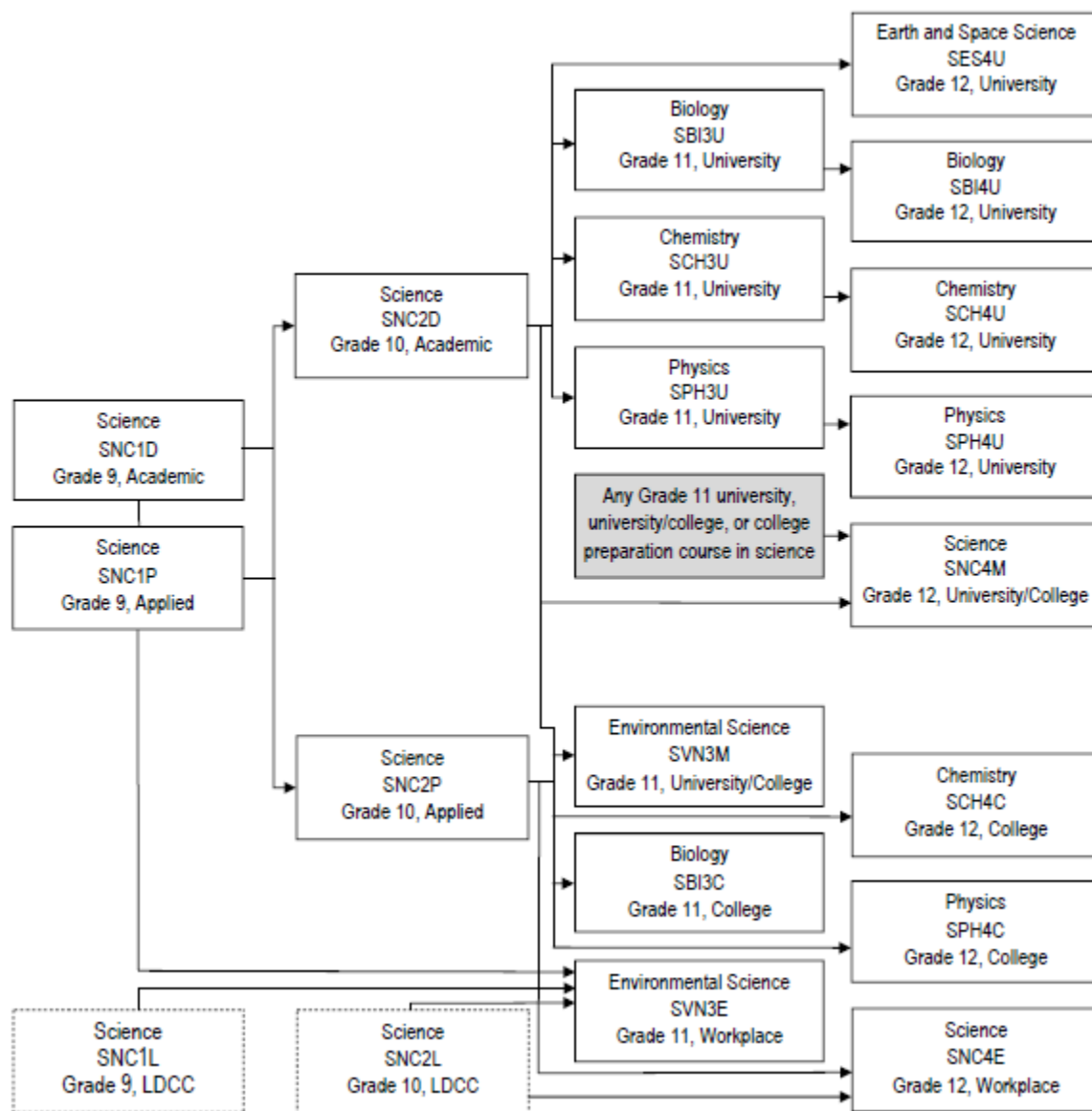

Prerequisite Chart for Social Sciences and Humanities: Social Sciences and Humanities, Grades 9-12

This chart maps out all the courses in the discipline by subject and grade, and indicates possible movement from course to course. It does not attempt to depict all possible movements from course to course.

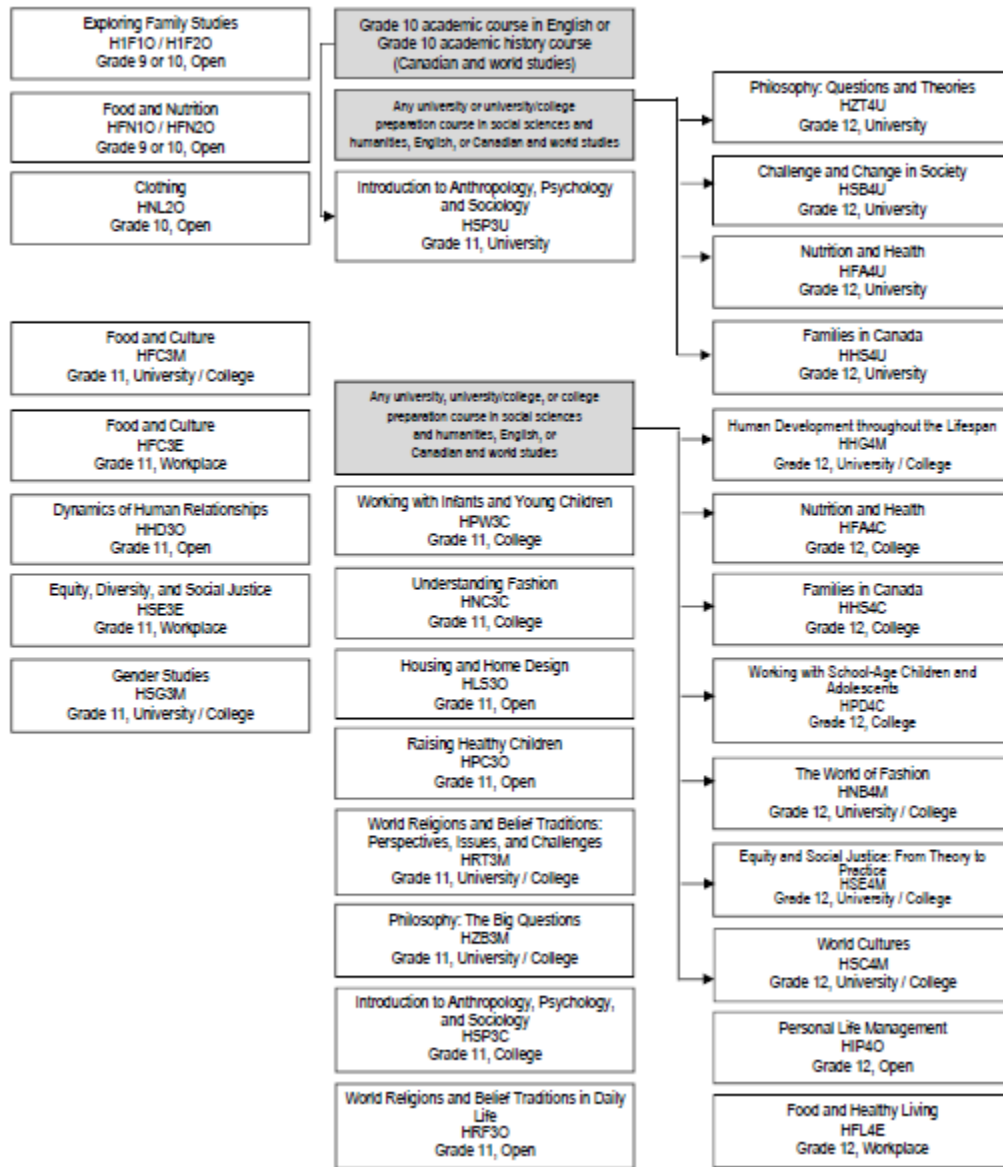

Prerequisite Chart for Technological Education, Grades 9-12

These charts map out the courses in the discipline and show the links between courses and the possible prerequisites for them. It does not attempt to depict all possible movements from course to course.

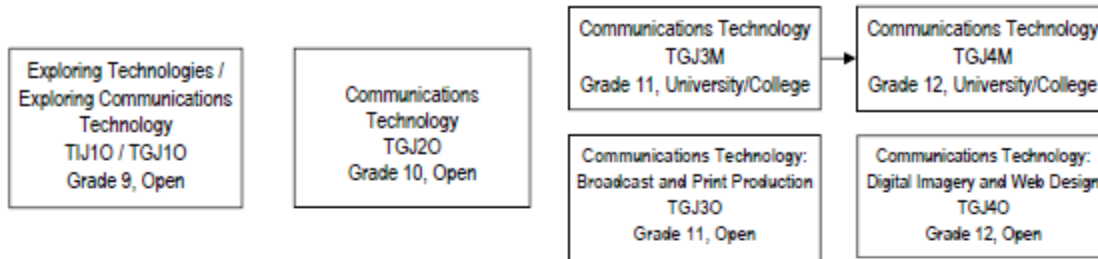

Computer Technology

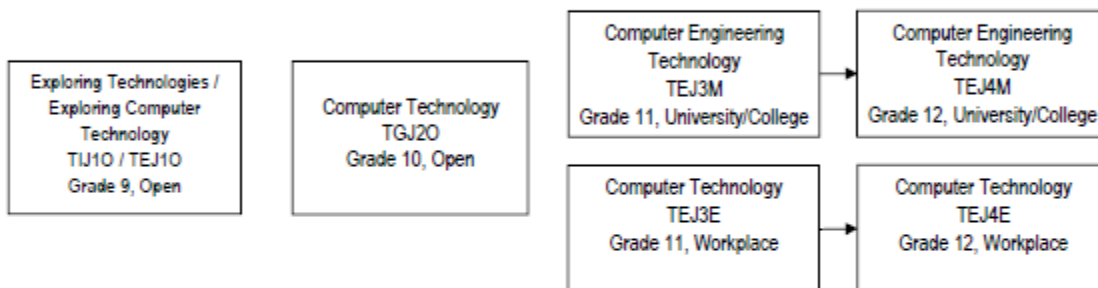

Construction Technology

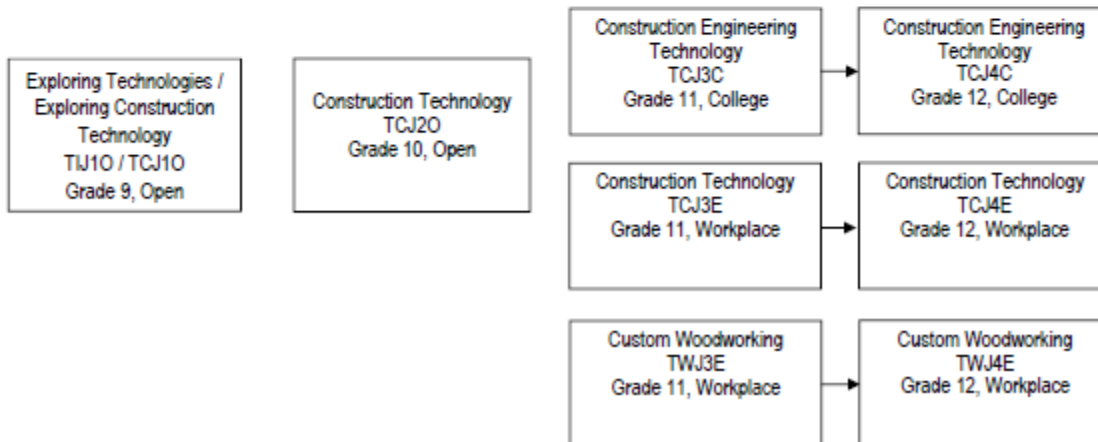

**Prerequisite Chart for Technological Education, Grades 9-12
(Continued)**

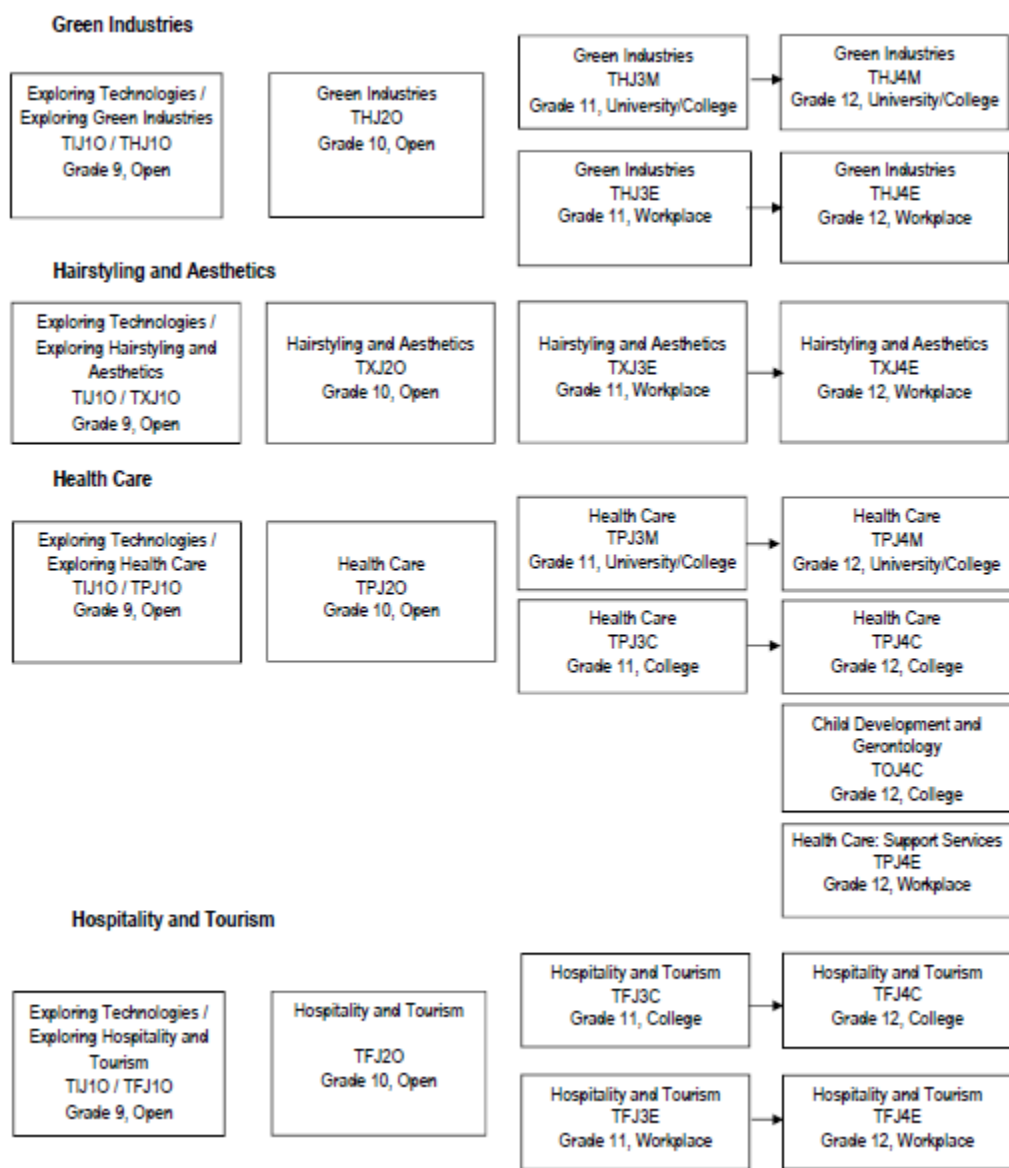

**Prerequisite Chart for Technological Education, Grades 9-12
(Continued)**

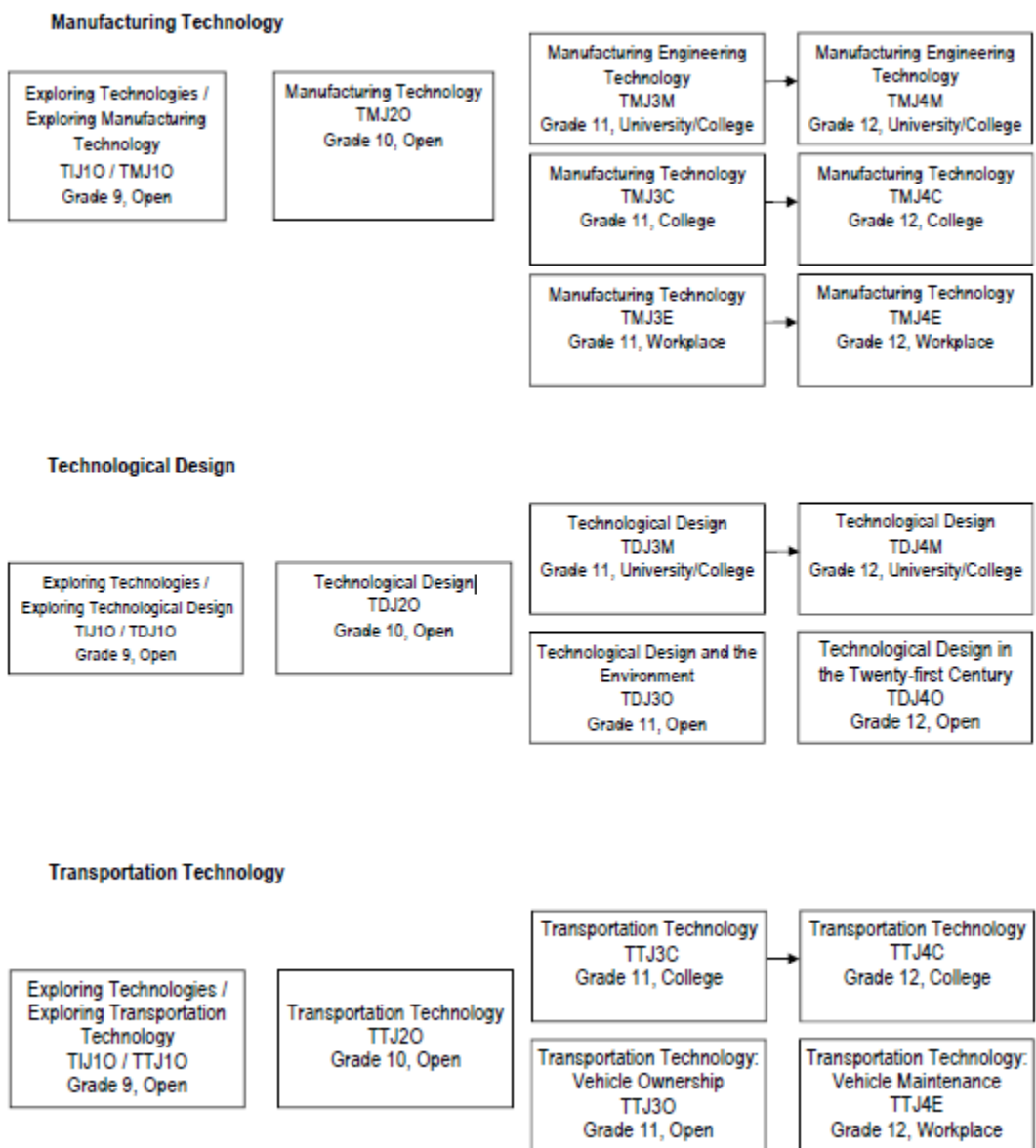

Course Codes for Emphasis courses in the Revised Curriculum: Technological Education, Grades 11 and 12 (2009)

<http://www.edu.gov.on.ca/eng/curriculum/secondary/techedemphasiscourses.pdf>

DETAILED COURSE DESCRIPTIONS can be found through the **Student Course Guide** links below for each high school:

Ancaster Secondary School

https://www.careercruising.com/Individual/CP_CourseCalendar.aspx?SID=912

Delta Secondary School

https://www.careercruising.com/Individual/CP_CourseCalendar.aspx?SID=4407

Dundas Valley Secondary School

https://www.careercruising.com/Individual/CP_CourseCalendar.aspx?SID=6957

Glendale Secondary School

https://www.careercruising.com/Individual/CP_CourseCalendar.aspx?SID=6098

Nora Frances Henderson Secondary School

https://www.careercruising.com/Individual/CP_CourseCalendar.aspx?SID=1534

Orchard Park Secondary School

https://www.careercruising.com/Individual/CP_CourseCalendar.aspx?SID=11857

Saltfleet Secondary School

https://www.careercruising.com/Individual/CP_CourseCalendar.aspx?SID=6715

Sherwood Secondary School

https://www.careercruising.com/Individual/CP_CourseCalendar.aspx?SID=13993

Sir Allan MacNab Secondary School

https://www.careercruising.com/Individual/CP_CourseCalendar.aspx?SID=8521

Sir John A Macdonald Secondary School

https://www.careercruising.com/Individual/CP_CourseCalendar.aspx?SID=3545

Sir Winston Churchill Secondary School

https://www.careercruising.com/Individual/CP_CourseCalendar.aspx?SID=6714

Waterdown Secondary School

https://www.careercruising.com/Individual/CP_CourseCalendar.aspx?SID=16696

Westdale Secondary School

https://www.careercruising.com/Individual/CP_CourseCalendar.aspx?SID=6716

Westmount Secondary School

https://www.careercruising.com/Individual/CP_CourseCalendar.aspx?SID=6717

SPECIALIZED PROGRAMS - DELIVERY OPTIONS

ONLINE LEARNING / e-LEARNING

Hamilton-Wentworth District School Board has a large variety of e-Learning courses available. e-Learning courses allow students to work online in a more independent learning environment, engage in interactive and inquiry-based learning activities and discussions, and enable students to work in a more flexible environment and timeline for their courses and personal schedules. For more information, please visit the board website at www.hwdsb.on.ca/secondary/programs/elearning.

SYSTEM ALTERNATIVE EDUCATION

System Alternative Education (SAE) provides flexible educational programs in order to meet the needs of students who have not experienced success in the traditional school setting. These programs are located in select secondary schools and off-site locations in the City of Hamilton. The focus is on re-engaging students through a variety of program models to establish a viable pathway to secondary school graduation.

Entry into SAE is through an application prepared at the home school in consultation with the student, caregiver, Student Success Team (Social Worker, Guidance, Learning Resource, Student Success Lead and School Administration). Applications are accepted throughout the school year, and placement is determined by a Central Intake Committee.

System Alternative Education is part of the HWDSB System Programs, which also consists of Care, Treatment, Custody and Corrections Programs, Gateway Safe & Accepting Schools Program, and SAL (Supervised Alternative Learning).

For more information on System Programs, contact your school's Student Services office and/or visit <http://www.hwdsb.on.ca/altered/>

SYSTEM SELF-PACED/SELF-DIRECTED LEARNING PROGRAM AT WESTMOUNT SECONDARY SCHOOL

Program Description:

Westmount Secondary School promotes the pursuit of excellence within a culture of respect and personal responsibility. Located on the west mountain in Hamilton, Westmount is a unique and dynamic secondary school that promotes self-pacing and self-direction. Westmount is a system program, and as such, students throughout the Hamilton-Wentworth District School Board can choose to attend, but please note, transportation between home and school is the responsibility of the student/parent/guardian.

At Westmount, students are encouraged and required to take responsibility for their own learning. Westmount aims to develop independence, self-advocacy, and decision-making skills in its students. The Westmount self-paced, self-directed program is best-suited to students who want to further their development of goal-setting, time management, and initiative learning skills.

The courses are designed so students can collaborate with their teachers to determine how their learning will be demonstrated; this might occur while students work on inquiries of their choice. Students may work to their strengths and therefore are permitted to “fast-track” a course and finish it before the end of the semester. Also, students may take more time on a course that they find challenging as long as there has been continuous progress. In both situations, there is intentional collaboration between the teacher, student and parent/guardian in the learning process.

School policies are developed to accommodate and encourage continuous progress and accountability. Daily attendance is a school expectation; however, students are able to organize their time and efforts according to their priorities. As well, all students are assigned an Advisor who helps monitor student progress, and distributes monthly reports to students. Students have an advisor period generally twice a month, one day before a flex day, so that they can plan their schedules for the following day. Flex Days allow students to flex their schedule so they can focus on their priorities. For example, a student may choose to spend 4 periods focusing on one subject.

Grade 8 students can apply for admission to Westmount by completing a *Notice of Intent* and submitting their final grade 7 report card and their most recent grade 8 report card. Particular attention will be paid to students' learning skills. Complete details and applicable forms may be found on Westmount's school website. If accepted, students within our Board will enter options through Career Cruising, while students from out-of-Board will submit hard copies of option selection requests as well as other paper work (available on the school website).

Grade 10 to 12 students who wish to transfer to Westmount can obtain the registration package on the Westmount web site. Interested applicants will be required to provide a transcript, recent report card, and a completed Student Application to Register Form. Each student's information will be reviewed by the principal, and the student will be contacted regarding the status of their application to Westmount. An interview with the principal may be requested.

Please visit the school website at: <http://www.hwdsb.on.ca/westmount/>

Tours are available at various times of year – if interested, please email Ms.Roberta Haddad at rhaddad@hwdsb.on.ca.

S.H.A.E. (STRENGTHENING HAMILTON'S ABORIGINAL EDUCATION)

ALTERNATIVE EDUCATION PROGRAM AT THE HAMILTON REGIONAL INDIAN CENTRE, 34 OTTAWA STREET NORTH, HAMILTON, ONTARIO, L8H 3Y7

Hamilton-Wentworth District School Board has partnered with the Hamilton Regional Indian Centre to create an alternative education program for Indigenous students wishing to continue their educational career. The objectives of this partnership are::

- To strengthen educational opportunities for First nation, Métis, and Inuit students
- To increase the pathways available to First nation, Métis, and Inuit students to complete their secondary school diploma or successfully transition to postsecondary education and training and/or the workplace
- To provide culturally relevant services and options to support the First nation, Métis, and Inuit students enrolled in the program.

For additional information on the Indigenous Education within the HWDSB, please visit the website below, and/or contact System Programs at (905) 383-5111, or the Hamilton Regional Indian Centre at (905) 548-9593.

<https://www.hwdsb.on.ca/elementary/supports/aboriginal-education/>

DUAL CREDIT PROGRAMS

In Dual Credit Programs, participating students are able to experience and gain credit for college and/or apprenticeship courses while still enrolled in high school. Successful students will earn credit toward both the OSSD and a college diploma or certificate, or the OSSD and a Level 1 Apprenticeship. For more information about Dual Credits, please visit <https://www.hwdsb.on.ca/secondary/programs/experiential-learning/dual-credit-program/>.

HWDSB students are able to participate in a variety of Dual Credit Programs at Mohawk College. Students in regular Dual Credit Programs attend Mohawk College for half a day and attend their home school for the other half of the day. Dual Credit teachers are high school teachers who support the Dual Credit students while they attend their college classes. They counsel the students, offer tutorial assistance and share information between the high schools and the college.

The college courses are all courses that are included in the course package for various Mohawk diploma, certificate or apprenticeship programs, and are taught by Mohawk instructors.

Dual Credit students are part-time Mohawk students with all the rights and privileges of any other part-time Mohawk student. Successful students will earn college credits towards a diploma or certificate for the courses on their college transcript if they attend a college in the future, and two optional credits towards the OSSD on their high school transcript. OYAP students earn the Level 1 Apprenticeship “in-school” component of their apprenticeship training.

Applications are encouraged from students who should consider college as a post-secondary destination but may be at-risk of not graduating or are unsure that they are ready for college. Applicants should have met the Literacy Requirement and be close to graduating. Successful completion of Grade 12, college or university English is preferred.

Dual Credit Programs include:

- Mohawk Bridge Dual Credit: two General Education courses such as Psychology and Environmental Sustainability
- Media Dual Credit
- Bridge to Social Services: Introduction to Recreation Therapy and Social Service Work
- Trades, Engineering and Design Dual Credit: AutoCad and Math courses
- Graphics and Animation Dual Credit
- Welding and AutoCad

Accelerated OYAP Dual Credits

A student applying for an OYAP Accelerated Level 1 program must be at least 17 years of age, have completed at least 24 credits, and have successfully completed a Cooperative Education placement in the trade. A student applying for OYAP Accelerated Level 1 is interested in pursuing this apprenticeship pathway beyond secondary school. Students in OYAP Accelerated Level 1 Programs combine full-day co-op with attendance at the Training Delivery Agent, Mohawk College or LiUNA.

Ontario Youth Apprenticeship Program (OYAP) Accelerated Level 1 Programs include:

- Level 1 Automotive Service Technician Apprenticeship Dual Credit
- Level 1 Child and Youth Worker Apprenticeship Dual Credit
- Level 1 Child Development Practitioner Apprenticeship Dual Credit
- Level 1 General Carpenter Apprenticeship Dual Credit
- Level 1 Truck and Coach Apprenticeship Dual Credit

Note:* Students must obtain 60% or higher in each unit of the Apprenticeship Curriculum to be able to obtain the Level 1 status as required by The Ministry of Training, Colleges and Universities.

EXPERIENTIAL LEARNING PROGRAMS

“Get Experience!”

Experiential Learning includes all planned learning experiences that take place outside of the classroom including *co-operative education, work experience, job twinning and job shadowing*. This unique form of learning can assist all students (including exceptional students) to develop the knowledge, skills and attitudes that are essential in today's society. Regardless of the post-secondary destination students choose (apprenticeship, college, community living, university or the workplace), Experiential Learning can help them to make key decisions and potential career choices. Hamilton-Wentworth District School Board offers a wide range of experiential learning opportunities to meet the needs of every student.

CO-OPERATIVE EDUCATION

Co-operative Education is one form of experiential learning that allows students to gain career awareness while developing their personal portfolio and earning credits towards their OSSD through practical work experience. It is designed in such a way that structured out-of-school activities complement in-school learning. In this way, theory and practice can be combined in an educationally beneficial manner. Students participate in a variety of career education and planning activities during pre-placement and reflective learning sessions as part of the co-op program.

Co-operative Education allows the student to:

- Explore potential career choices;
- Develop employability skills needed in today's job market;
- Improve qualifications for future employment;
- Have access to equipment not available in schools;
- Earn secondary school credits while gaining practical work experience;
- See the relevance of in-school theory as it applies to practical work application;
- Understand the importance of education to a particular career; and
- Develop skills related to a specific career by working with trained professionals.

In consultation with their Co-op teachers, students will have the option of two (2) courses, as outlined below:

Creating Opportunities through Co-op, Grade 11, Open (DCO30)

This course consists of a community-connected experience and a cooperative education curriculum focused on developing skills, knowledge, and habits of mind that will support students in their learning at school and beyond, today and in the future, as well as in their education and career/life planning. Within the context of the community connected experience, students will apply skills, knowledge, and habits of mind that will protect and promote their health, safety, and well-being and that will strengthen their inquiry, decision-making, and leadership skills. Students will create and implement a learning plan that meets their particular interests and needs, reflect on their learning, and make connections between their experience in the community and other aspects of their lives.

Prerequisite: None

Cooperative Education Linked to a Related Course (or Courses)

This course consists of a community-connected experience and a cooperative education curriculum that incorporates relevant expectations from the student's related course (or courses). Students will develop skills, knowledge, and habits of mind that will support them in their learning at school and beyond, today and in the future, as well as in their education and career/life planning. Within the context of the community connected experience, students will apply, extend, and refine skills and knowledge acquired in their related course or courses and will apply skills, knowledge, and habits of mind that will protect and promote their health, safety, and well-being. They will create and implement a

learning plan that meets their particular interests and needs, reflect on their learning, and make connections between their experience in the community and other aspects of their lives.

Prerequisite: None

There is no formal restriction on the number of credits a student may obtain through the co-operative education mode of delivery; however, students should maintain a reasonable balance between in-school and out-of-school credits.

NOTE: Up to two credits earned through co-op can count towards the 18 compulsory credits needed for a high school diploma. Marks earned in Grade 12 co-op can also be used to calculate overall average for Ontario Scholarship Award.

NOTE: All students who apply for the co-op program are interviewed by a co-op teacher and will be selected to participate based on their suitability for the program (type of placement requested/available, credit and diploma requirements, access to transportation, dependability etc.). It is important that students begin planning for their co-op placement early as many placements are competitive and are arranged well in advance.

Co-op is available at every HWDSB Secondary School.

Co-op is the only way to be involved in the Ontario Youth Apprenticeship Program (OYAP)

Co-op is a required component of all Specialist High Skills Major programs.

SPECIALIZED “SYSTEM” EXPERIENTIAL LEARNING AND SCHOOL – WORK TRANSITION PROGRAMS

School-work transition programs are specialized programs that prepare students for employment. Most of these programs are provided for students intending to enter the workforce directly from high school, but may be suitable for students considering any post-secondary destination (apprenticeship, college, university, or the workplace). These programs include both in-school and work-based experiences. Many of our high schools offer some type of school-work transition programs. For information about other school based programs, contact the Student Services Department at your school.

Some specific programs are described below. These “system programs” are offered through a central application process, and are open to students from all schools.

Healthcare Support Services Program

The Healthcare Support Services Program provides authentic, hands-on, hospital-based learning experiences for senior secondary students in all destinations (college/university/workplace) with an interest in pursuing a healthcare career.

The program design enables students to gain the necessary knowledge, skills and behaviours they will need to participate in related co-operative education experiences in customer support services roles at all Hamilton Health Sciences (HHS) hospital sites e.g., Environment Aide and Porter. This unique experiential learning opportunity is being offered in partnership with Hamilton Health Sciences as a four-credit program each semester. The classroom and skills lab are located at the Juravinski site, and the co-op placements are available at the McMaster, General, Juravinski and St. Peter’s sites in units as varied as Emergency Room, Intensive Care Unit, Pediatrics, Orthopedics, and many others. The credits obtained through this program as well as the industry-recognized certifications and training can all be used towards obtaining the Specialist High Skills Major designation in Health and Wellness on the Ontario Secondary School Graduation Diploma.

Students Will Learn:

- Principles of immunology and infection control;
- An overview of the healthcare industry including health and safety issues in healthcare, Service Excellence in patient care, safe body mechanics, Waste Management training and so much more;
- An overview of human anatomy & physiology, and basic medical terminology as well as healthcare skills including taking vital signs and performing patient transfer and transport procedures; and
- Healthcare career opportunities through interactions with a variety of healthcare professionals within the classroom and the local healthcare community.

During this all-day semester-long program, students will have the opportunity to:

- Earn four Grade 12 credits (one Healthcare credit TPJ4M/4C/4E, one Science credit SNC4M/4E and two credits through co-operative education available as C, E or M credits), as well as industry-recognized certification and training in First Aid/CPR, WHMIS, Infection Control, Safe Body Mechanics, Medical Terminology, etc.;
- Spend the entire semester at Hamilton Health Sciences with a HWDSB teacher and a variety of healthcare workers within one of three acute care hospital sites; all in-class instruction will be held at Juravinski Hospital;
- Participate in three different co-op experiences of your choice at any of the Hamilton Health Sciences sites including areas such as Emergency Department, Intensive Care Unit, Burn Trauma Unit, Pediatrics, Operating Room and many more!;
- Develop the skills necessary for success in a healthcare career;
- Make contact with the largest healthcare employer in the region; and
- Receive certification in Healthcare Support Services endorsed by Hamilton Health Sciences and Hamilton-Wentworth District School Board upon successful completion of the program.

Contact the Student Services or co-op office at your school for an application form. Apply now!

Lime Ridge Community Co-op Program

The Lime Ridge Community Co-op Program has had a change in location, but has not changed in focus. The program has recently moved and is now located at Nora Frances Henderson Secondary School. This four-credit (full semester, all day) program gives students an opportunity to earn one credit in “Discovering the Workplace” (GLD2O1), one credit in “Navigating the Workplace” (GLN4O1) and two credits in an appropriate related course through co-operative education. The two in-school courses offered in this program are intended to help students develop the knowledge and skills necessary for success in today’s workplace. The program allows students the opportunity to explore future career options while engaging them in education through work.

While many co-op placements are typically located in the Lime Ridge Mall area, placements can be anywhere in Hamilton or the surrounding area. There is not a specific focus on retail placements, but rather on trying to match students with a placement in which they can excel and be successful. This program accepts applications on a “continuous intake” basis and students from any secondary school in the Hamilton-Wentworth area are invited to apply at any time during the semester (until such time as the program is full).

“Discovering the Workplace” (GLD2O1) helps students identify and develop the workplace essential skills and work habits that are required for success in the workplace. Through various experiential learning opportunities, students will prepare for, and complete, two work experiences in Lime Ridge Mall or within the Hamilton-Wentworth community.

“Navigating the Workplace” (GLN 4O1) will enable students to further develop the workplace essential skills and to explore the workplace through experiential learning opportunities. The combination of course material, work experiences and co-operative education will assist students in making a smooth transition from high school to their chosen post-secondary destination.

For additional information, please contact:

- Your home school Student Services Department
- Nora Frances Henderson Secondary School, 75 Palmer Road, Hamilton, Ontario, 905-389-2234
- System Programs 905-383-5111

“Building Careers From The Ground Up” Residential Construction Program

This is a unique all day, full semester program. It provides students with the opportunity to experience the many skilled trades available in the home building industry. Students have the opportunity to earn credits in Senior Construction Technology through in class and co-operative education modes of delivery. Students will also obtain Working at Heights Training, WHMIS Certification, CPR, First Aid and other sector specific certifications. In the process, they will construct a house from the foundation up, together with one of our community partners. This program started in 2002 with a house we built for Homes By DeSantis in Stoney Creek. Since the program started we have built one house a year, partnering with John Bruce Robinson Construction Ltd. in Binbrook, New Horizon Homes in Burlington, Landmart Homes in Stoney Creek, and we have an ongoing partnership with Habitat for Humanity.

Students will:

- Develop skills necessary for success in the highly competitive work of home construction;
- Be eligible for apprenticeship opportunities through the Ontario Youth Apprenticeship Program (OYAP);
- Develop critical skills that are transferable to any post-secondary destination and the world of work; and
- Connect with potential employers for future employment.

This program is now offered in each semester. Long days and relevant co-op placements allow students to earn up to six credits. The credits obtained through this program as well as the industry-recognized certifications and training can all be used towards obtaining the Specialist High Skills Major (SHSM) designation in Construction on the Ontario Secondary School Diploma.

Students interested in applying should contact Student Services. Applications are always being accepted, but get yours in today!

CANADIAN FORCES ARMY RESERVE Co-op Program

The Army Reserve Co-op Program is an opportunity for students to gain experience in a military environment, develop self-confidence, leadership and teamwork skills, while earning high school credits. This program runs during semester two only.

Students spend the semester at the Armoury (James Street North, Hamilton), arriving every morning and returning home every evening. Students may be required to work several weekends/evenings over the semester, but generally do not train on weekends. The student will attend high school classes at the Armoury in the morning (two credits – one in Phys. Ed. and one in Math). Students complete their Basic Military Qualification (BMQ) training in the afternoon (two credits through co-op).

Students in this program are signed into one of the Reserve Units participating in this program. Students in this program are paid approximately \$212 (gross pay) per week for the military training portion of the program. There is no cost for the uniform and field equipment.

Upon completion of the program, successful students can continue with their unit on a part-time basis (approximately one night per week, and one weekend per month – paid). Employment for the summer is also available for students who successfully complete the co-op program.

THE ONTARIO PUBLIC SERVICE (OPS) Learn and Work Program Coop Program

The OPS Learn and Work Program is for students who are not engaged in school or have otherwise dropped out. It provides an opportunity to continue their education through a classroom component and co-operative education. Students will have the opportunity to earn secondary school credits while completing a specialized co-operative education placement in the Ontario Public Service (OPS) and its related agencies. Students will be placed in government entry level positions or with a non-profit organization. This four credit, all-day program begins in a classroom learning environment for the first seven weeks. Upon successful completion, students will continue a co-op placement for the last ten weeks of the program. This program is offered in both semesters. Students must have or be willing to get proper identification for the program including a birth certificate, social insurance number, passport, license, or Ontario Photo Card.

Classroom Component:

- Students must be between the ages of 16-20 years;
- Monday – Friday 9:00 a.m -1:00 p.m.;
- Working on GLD2O1, GLN4O1 or GWL3O1;
- Develop workplace essential skills and transferable skills;
- Create success and make positive changes;
- Classes take place at Bernie Custis Secondary School; and
- Must complete a successful interview with Ministry representatives to move to the workplace component.

Workplace Component:

- Students are paid minimum wage during their work placement;
- Hours are full days Monday – Thursday, with classes on Fridays;
- Students are able to access the Employee Assistance Program;
- Employers are selected through an application process;
- Students are matched to employers based on student's skills; and
- Students will develop skills necessary for the workforce.

For additional information, please visit: www.hwdsb.on.ca/delta/ontario-public-service-ops-paid-coop

ART SMART PERFORMING ARTS CO-OP PROGRAM

The Art Smart program is intended to provide experiential learning opportunities for secondary students pursuing a career in the performing arts or for those who simply have a love for the arts. Students from secondary schools across the district may attend Sir Allan MacNab in second semester to receive intensive, specialized arts training through a highly focused four credit course package (including two co-op credits), tailored to the individual. Students will gain the necessary knowledge, skills and experience to prepare them for post-secondary arts programs for college, university, or apprenticeship placements as well as connections to local theatre companies.

The credits obtained through this program, as well as industry-recognized certifications and training, may all be used towards obtaining the Specialist High Skills Major designation in Arts & Culture on the Ontario Secondary School Graduation Diploma.

Experiential Learning:

- Performance focused students will develop skills in drama, vocal music, music and dance while students interested in stage production will develop skills in their choice of set, costume and technical design.
- All students will work collectively to produce a major musical production that will entertain an extensive audience, through a two-week run of live performances.

- Students will participate in a variety of workshops with community arts specialists from Theatre Ancaster, Theatre Aquarius, the Hamilton Conservatory for the Arts, the Shaw Festival, the Stratford Festival, and others, to gain enhanced, practical knowledge of each specific arts discipline.
- Students will work directly with professional theatre staff from Theatre Ancaster and experienced teachers to mount this production, thus creating links to a prominent community theatre.
- Students will take a two credit co-op course, a music theatre course and choose from the following course options: Drama (ADA3M1 or ADA4M1), Vocal (AMV2O1, AMV3M1 or AMV4M1), Dance (ATC2O1, ATC3M1 or ADA4M1), Stage Design or Fashion.

Contact Student Services, the co-op office at your school, or visit the Sir Allan MacNab's website at www.hwdsb.on.ca/macnab. Apply now!

OYAP - Ontario Youth Apprenticeship Program

The Ontario Youth Apprenticeship Program (OYAP) allows students to attend high school and explore a career in an apprenticeable trade as a registered Participant with the Ministry of Training, Colleges and Universities. Students must be at least 16 years of age, with at least 16 credits. The OYAP program, available in all HWDSB secondary schools, allows students to get a head-start earning hours and competencies toward an apprenticeship. OYAP begins as a cooperative education placement, working with people in the apprenticeable trades. The co-operative education component provides both the student and the employer with the opportunity to determine if apprenticeship is a suitable option. If the student and employer are both in agreement, the Apprenticeship Branch of the Ministry of Training, Colleges and Universities is contacted to register the student as an apprentice. Further information can be obtained through your Guidance Counsellor, Technological Studies teacher or Co-operative Education teacher, or through the board OYAP Consultant. For more detailed information, please visit this link:

<http://www.hwdsb.on.ca/secondary/programs/ontario-youth-apprenticeship-program-oyap/>

What is an Apprenticeship?

An apprenticeship is a Registered Training Agreement between a person who wants to learn a skilled trade and an employer who needs a skilled worker. It involves a combination of on-the-job training under the supervision of a licensed journeyman (a person who has mastered the skills of an occupation) and in-school training. The Ministry of Training, Colleges and Universities (MTCU) registers this agreement. While the trainee is still a student, the OYAP Consultant assists with the communication and record keeping for the student, the HWDSB, and the MTCU.

Benefits to youth:

- Provide a start in a chosen career along with the flexibility for later career changes;
- Ease the transition from school to work;
- Increase opportunities for post-secondary training and employment;
- OYAP students *may* earn a wage in addition to earning a secondary school credit;
- Develop both specialized and general employability skills including: problem solving;
- Decision-making, teamwork, good work habits, confidence, and self-reliance;
- Develop an understanding of employer expectations in the work world and the need for lifelong learning; and
- Receive training and employment opportunities within the Hamilton-Wentworth Region.

There are more than 150 Apprenticeable trades in Ontario, and a student can get experience in many of these through an OYAP co-op placement! Some of these include: Brick and Stone Mason, Automotive Service Technician, Auto Body and Collision Repair, General Machinist, Electrician, Horticultural Technician, Hairstylist, Truck and Coach Mechanic, Painter, Cement Finisher. For a complete list, go to the Student Services Dept. at your school, or talk to the OYAP Contact Teacher in your school.

How do you get started?

If you are at least 16 years old, and will have at least 16 credits, talk to the Student Services Department in your school. Choose co-op to get started. This program is open to Grade 11, Grade 12 or “Post-Grad” students. (Please see individual school and school-specific courses for some of our specialized OYAP programs).

Accelerated Ontario Youth Apprenticeship Programs

As described above, OYAP is available at all high schools through the regular co-op program. In addition, several specialized programs are available.

Level 1 Automotive Service Technician Apprenticeship Dual Credit

This specialized program is offered in partnership with Mohawk College, MTCU and other local school boards. This program is offered to senior students and post-graduate students from every secondary school in the HWDSB. Students will attend Mohawk College for an 8 week block, and will be at a co-op placement for the other weeks of the semester. The cost of this program is funded by the MTCU. Successful students may earn up to four credits.

- Students must be scheduled for an all day Automotive Co-op placement during Semester 2 (Feb. - June);
- Students must be signed apprentices;
- A previous co-op experience should be used to help with this (i.e. Grade 11 co-op experience convinces employer to sign student up and take part in this program for Grade 12);
- Students must take at least one Grade 12 Transportation Technology course and should have successfully completed a Senior Math and/or Physics course;
- Students will be enrolled in their “home school” for the co-op program, and will be considered a full time student at their home school;
- The Mohawk College course is the first level of “in-school” apprenticeship training (commonly called “Trade School”).

Upon successful completion Level 1 Automotive Service Technician Apprenticeship Dual Credit students will earn credit for the in-school component of the Level 1 Automotive Service Technician Apprenticeship and two optional credits towards the OSSD on their high school transcript.

Level 1 Child Development Practitioner Apprenticeship Dual Credit

This specialized program is offered in partnership with Mohawk College, MTCU and other local school boards. This program is offered to senior students and post-graduate students from every secondary school in the HWDSB. Students will attend Mohawk College for two days a week, and will be at a co-op placement three days a week. This two semester program begins Semester 2 (February - June) and continues the following Semester 1 (September - January). The cost of this program is funded by the MTCU. A successful student may earn up to four credits.

- Students must be scheduled for an all day Child Development Practitioner Co-op placement.
- Students must be signed apprentices. A previous co-op experience should be used to help with this (ie. Grade 11 co-op experience convinces an employer to sign a student up as an apprentice, and take part in this program for Grade 12).
- Students should have successfully completed one Grade 12 Family Studies course and a Senior English course.
- Students will be enrolled in their “home school” for the co-op program, and will be considered a full-time student at their home school.
- The Mohawk College course is the first level of “in-school” apprenticeship training (commonly called “Trade School”);
- Students can enroll in either September or February.

Dual Credit teachers support the Child Development Practitioner Apprenticeship Dual Credit students while they attend their college classes. They counsel the students, offer tutorial assistance and share information between the high school and the college.

If they are successful, Child Development Practitioner Dual Credit students will earn credit for the in-school component of the Level 1 Child Development Practitioner Apprenticeship and two optional credits towards the OSSD on their high school transcript.

Level 1 Child and Youth Worker Apprenticeship Dual Credit

This specialized program is offered in partnership with Mohawk College, MTCU and other local school boards. This program is offered to senior students and post-graduate students from every secondary school in HWDSB. Students will attend Mohawk College for two days a week, and will be at a co-op placement three days a week. The cost for this program is funded by MTCU. A successful student may earn up to four credits.

- Students must be scheduled for an all day Child and Youth Worker Co-op placement;
- Students must be signed apprentices;
- A previous co-op experience should be used to help with this (i.e. Grade 11 co-op experience convinces an employer to sign a student up and take part in this program for Grade 12);
- Students should successfully complete at least one Grade 12 Family Studies course and a Senior English;
- Students will be enrolled in their “home school” for the co-op program, and will be considered a full time student at their home school;
- The Mohawk College course is the first level of “in-school” apprenticeship training (commonly called “Trade School”);
- Students can enroll in either September or February.

Dual Credit teachers support the Child and Youth Worker Apprenticeship Dual Credit students while they attend their college classes. They counsel the students, offer tutorial assistance and share information between the high school and the college. If they are successful, Child and Youth Worker Dual Credit students will earn credit for the in-school component of the Level 1 Child and Youth Worker Apprenticeship and two optional credits towards the OSSD on their high school transcript.

*NOTE * (Block 1 is not a prerequisite for Block 2, students may enroll in September for Part 2 and then take Part 1 the following February)*

Level 1 Construction Craft Worker Apprenticeship

This is a specialized program being offered in partnership with LIUNA Local 837 (Labourers International Trade Union of North America), MTCU and other local school boards. This program is offered to senior students and post-graduate students from every secondary school in the HWDSB. Students will attend LIUNA Local 837(Winona) for a block of eight weeks and will be at a co-op placement for the other weeks of the semester. The cost of this program is funded by MTCU. A successful student may earn up to four coop credits. Please note: this is not a dual credit program.

- Students must be scheduled for an all day Construction Co-op placement during Semester 2 (February - June);
- Students must be signed apprentices;
- A previous co-op experience should be used to help with this (i.e. Grade 11 co-op experience convinces employer to sign student up and take part in this program for Grade 12);
- Students must have successfully completed at least one Senior Construction course and a Senior English.

Students will be enrolled in their “home school” for the co-op program, and will be considered a full time student at their home school. The LIUNA Local 837 course is the first level of “in-school” apprenticeship training (commonly called “Trade School”).

Level 1 General Carpenter Apprenticeship Dual Credit

This specialized program is offered in partnership with Mohawk College, MTCU and other local school boards. This program is offered to senior students and post-graduate students from every secondary school in the HWDSB. The program is held at Mohawk College’s STARRT campus in Stoney Creek for the in-school Apprenticeship training. This class time is scheduled Monday thru Thursday from the second week of February until mid-April. Students will attend their co-op placement when not at STARRT. The cost of this program is funded by MTCU. A successful student may earn up to four credits.

- Students must be scheduled for a Construction Co-op placement during Semester 2.
- Students must be signed apprentices to be able to attend the in-school portion of the training.
- Previous experience should be used to help with this (i.e. Grade 11 co-op experience convinces employer to sign a student as an apprentice and take part in this program for Grade 12);
- Students must have successfully completed at least one Senior Construction course and a Senior English.

Students will be enrolled in their “home school” for the co-op program, and will be considered a full-time student at their home school. The Mohawk College course is the first level of “in-school” apprenticeship training (commonly called “Trade School”).

Upon successful completion, General Carpenter Dual Credit students will earn credit for the in-school component of the Level 1 General Carpenter Apprenticeship and two optional credits towards the OSSD on their high school transcript.

Level 1 Truck and Coach Apprenticeship Dual Credit

This specialized program is offered in partnership with Mohawk College, MTCU and other local school boards. This program is offered to senior students and post-graduate students from every secondary school in the HWDSB. Students will attend Mohawk College for an 8 week block, and will be at a co-op placement for the other weeks of the semester. The cost of this program is funded by the MTCU. Successful student may earn up to four credits.

- Students must be scheduled for an all day Truck and Coach Co-op placement during Semester 2 (Feb. - June);
- Students must be signed apprentices;
- A previous co-op experience should be used to help with this (i.e. Grade 11 co-op experience convinces employer to sign student up and take part in this program for Grade 12);
- Students must take at least one Grade 12 Transportation Technology course and should have successfully completed a Senior Math and/or Physics course;
- Students will be enrolled in their “home school” for the co-op program, and will be considered a full time student at their home school;
- The Mohawk College course is the first level of “in-school” apprenticeship training (commonly called “Trade School”).

Upon successful completion, Level 1 Truck and Coach Service Technician Apprenticeship Dual Credit students will earn credit for the in-school component of the Level 1 Apprenticeship and two optional credits towards the OSSD on their high school transcript. Dual Credits earned through OYAP Accelerated Level 1 programs may be applied to the Specialist High Skills Major designation.

Interested students should contact a Guidance Counsellor, Coop Teacher or Subject Teacher for more information and an application.

SPECIALIZED PROGRAMS (SCHOOL-BASED PROGRAMS)

At HWDSB, we know that each student is unique in his or her learning, and we work to ensure our programs help our students reach their full potential. In addition to the programming offered at neighbourhood schools, a number of SHSM and Specialized Learning Programs are available across the district.

SPECIALIST HIGH SKILLS MAJOR (SHSM)

Pursuing an SHSM enables students to:

- Customize their secondary school education to suit their interests and talents;
- Earn credits that are recognized by the sector and postsecondary education institutions;
- Develop specialized knowledge and skills that are valued by the sector and postsecondary education institutions;
- Gain sector-specific and career relevant certifications and training;
- Develop essential skills and work habits that are valued by the sector;
- Identify, explore and refine career goals and make informed decisions about post secondary destinations; and
- Remain flexible with the option to shift between pathways should goals and plans change.

What will I get for completing an SHSM?

- A special seal on your high school diploma as proof of your learning in this sector; and
- An SHSM record card outlining your certifications and specialized courses.

What kinds of opportunities exist?

- Arts & Culture – Dundas Valley, Glendale, Orchard Park, Sir Allan MacNab and Westdale
- Aviation & Aerospace – Ancaster and, Sir Winston Churchill
- Business - Dundas Valley, Glendale, Orchard Park and Waterdown
- Construction – Nora Henderson, Saltfleet and Westdale
- Environment – Waterdown and Westmount
- Health & Wellness – Bernie Custis, Orchard Park, Sherwood, Sir Allan MacNab, Sir Winston Churchill and Westmount
- Horticulture & Landscaping – Saltfleet
- Hospitality & Tourism –, Bernie Custis, Orchard Park, , Sir Allan MacNab and Westdale
- Information & Communications Technology – Ancaster, Nora Frances Henderson, Saltfleet and Westmount
- Justice, Community Safety & Emergency Services – Nora Frances Henderson
- Manufacturing – Dundas Valley, Nora Frances Henderson and Sir Winston Churchill
- Non Profit - Glendale and Saltfleet
- Transportation - Dundas Valley, Glendale, Nora Frances Henderson, Sherwood and Sir Winston Churchill

What's the best part?

- Gain confidence and skills in an area of interest;
- Make informed career decisions;
- Earn sector recognized certifications;
- Make connections with industry professionals; and
- Get a special seal on your diploma.

For more information about these programs, please review the website listed below, and/or contact Student Services at your local high-school: <http://www.hwdsb.on.ca/secondary/programs/shsm/>

Specialized Learning Programs in the HWDSB

Specialized Learning is used to define Ministry-mandated, unique, innovative learning programs in focused areas and is designed to engage students who have differing educational interests. The programs have the capacity to develop a broad range of skills and further enhance character development, academic achievement, and leadership development and may include languages, environmental studies, the arts, and fitness and wellness. These programs complement subjects/courses consistent with the Ontario Curriculum and offer specialized learning opportunities that develop skills with greater depth and intensity.

Students may engage in Specialized Learning at different elementary and secondary grade levels based on program availability and admission criteria. Secondary Specialized Learning may contribute to a Ministry approved Specialist High Skills Major when a career-focused pathway offering opportunities in apprenticeship, college, university and workplace exists.

Bikeology (Delta)

This is a project-based experiential learning program in which students learn basic bicycle repair skills and run a Bike Repair shop. Students gain practical hands on skills and develop leadership skills. Students also have the opportunity to connect with a variety of community partners. The program is located at Delta Secondary School and is a three credit package of courses. Students earn credits in English, Business Marketing and Technological Studies. To be eligible for this program students should be in Grade 11 or 12. Program runs based on enrolment.

Cosmetology (Delta, Orchard Park, Sherwood, Waterdown)

This course is offered in grades 9-12. It is a hands on technological education program that allows the student to learn industry standards in the hairstyling field which include: health and safety, personal grooming, hair design, hair cutting, hair colouring, trends in hairstyling, basic skin and aesthetic treatments as well as business and retail. This program is located at four schools including Delta, Orchard Park, Sherwood and Waterdown.

Fashion

The HWDSB fashion program offers the opportunity to develop your fashion design and construction skills, deepen your knowledge of cutting-edge fashion tools and trends, make proper decisions with fabric and clothing care, choice and consumerism. Through hands-on projects, lectures, discussions, guest lecturers, and critiques, students will:

- explore the purpose and function of fashion, fashion influences, design concepts, fabric and fibre, production, marketing, fashion cycles and trend research, and environmental factors;
- use inquiry based learning, as well as conventional and digital techniques to research, develop and present your ideas.

Young and Expecting Parent Program (YEPP)

This program for young and expecting parents (male or female) aged 14 to 21 is located at Sir John A MacDonald Secondary School. Students are able to bring their infant to the classroom with them. Students work with a Secondary School teacher to earn credits and also receive hands on parenting support from an Early Childhood Educator. Students have the opportunity to learn alongside other young parents and connect with a variety of community resources such as the Ontario Early Years Centres. Interested students should speak with a guidance counsellor at their school for registration information.

ARTS AND CULTURE

NuSteel Program - Where the studio IS the classroom! NuSteel is located in the heart of Hamilton's Arts community on James St. North and is available to students with an interest in pursuing possible careers in the arts.

The referral process for this program is through Central Intake, and we also welcome referrals for students in the care of CAS, via their case workers. Students taking part in the NuSteel program have an opportunity to engage in cross-curricular projects that culminate in hand-printed products, including posters, t-shirts, bags, and postcards in addition to fine art pieces. The program covers a variety of subjects, including English, Visual Art, Media Art, History, Careers and Civics as well as possible co-op opportunities. At Centre3, students have the opportunity to participate in Hamilton's monthly Art Crawls, and experience the life of an artist-entrepreneur. Students also have the opportunity to work within a community of artists, to observe artists in their craft, and to learn valuable new skills in this rich environment.

Indigenous Arts at Sir John A. Macdonald. Additional schools on a year by year basis.

The strong academic course offerings have been made possible with the assistance of the arts departments and NYA: WEH initiative at both schools.

NAC 101: Expressing Aboriginal Cultures

In this hands-on introductory course, students will explore various visual art media as they discover the rich cultural heritage of indigenous people in Canada. Working with cultural advisers, Elders, guest artists and working First Nations craftsmen, students will begin to develop familiarity with native drumming, drum-making, printmaking, painting and ceramics. This course is open to all individuals wishing to dispel ignorance with knowledge!

NAC 201: Expressing Aboriginal Culture

In this advanced level Indigenous Arts class, students will explore contemporary indigenous issues through the arts. Engraving, videography, collage, zines and painting are just a few of the vehicles that students will be encouraged to employ while continuing to work with the rich cultural teachings of Canada's indigenous peoples. In each session there are also special projects and productions that allow students incredible opportunities to work with contemporary indigenous artists known throughout the world!

NDA3M: Cultural And Aboriginal Issues In Canada

This exciting university/college preparation course offers students not only a look at the history of indigenous peoples within North America, but focuses on covering many wide-ranging and interesting issues that indigenous people face today. Emphasis is on not only classroom materials and teachings, but on visits from important people in the indigenous community such as Elders, and even offers several trips to important sites and museums throughout the semester. This course is open to all students to gain a deeper understanding of Canada's First Nations: their importance, heritage, history and legacy.

HWDSB Strings at Glendale

Glendale Secondary School (145 Rainbow Drive, Hamilton) hosts a specialized learning opportunity for students to study music in its dedicated Strings program which includes violin, viola, cello and bass. As a Tier 3 HWDSB program, students from any HWDSB secondary school can attend Glendale for HWDSB Strings. Transportation will be provided to the Tier 3 program at Glendale under HWDSB Transportation Policy & Procedure.

In the HWDSB Strings Program students study music through the performance, creation and analysis of an exciting variety of classical music periods extending into the 21st century. Students may consider and attend beginner to advanced courses. Strings courses build upon strings programs taught at HWDSB elementary schools through CCE or in the community.

The HWDSB Strings Program at Glendale is offered in partnership with the HWDSB Program of the Arts, the Arts and Culture SHSM, and the Instrumental/Vocal Music Program at Glendale, which includes offerings in vocal, instrumental, guitar, keyboard and the visual and performing arts. Glendale offers a full complement of extracurricular ensembles for all music students.

This program can lead to a Specialist High Skills Major (SHSM) designation in Arts and Culture or as part of the HWDSB Audition Based Program of the Arts. . Please see your Guidance Counselor for further information.

HWDSB Audition Based Program of the Arts at Glendale

This program trains students in all aspects of the Arts including Foundations of Theory and Technique, Individual and Collaborative Creation and Performance, and Critical Analysis. Students major in one of eight disciplines: Dance, Drama (Performance and Production); Music (Instrumental Band, Strings, Guitar or Vocal); or Visual and Media Arts. In addition to required credits, students have experiential learning opportunities such as career exploration, professional certification, discipline-specific training, opportunities beyond the classroom and seasonal collaborations on large-scale stage productions and exhibitions, small-scale studio production and exhibitions and informal studio productions and exhibitions that invite broader school participation.

Students at each grade level can enter the program and expect to work with guest artists, attend performances and exhibitions and regularly perform or exhibit their own work. Arts department staff are specialists in their field who regularly welcome community artists to work directly with students.

Graduating students receive a Certificate of Recognition in the Arts and Additional Qualifications such as industry training, professional resume and headshot, and professional portfolio. Students may also complete this program in collaboration with HWDSB Tier 3 Strings and the Specialist High Skills Major (SHSM) Arts and Culture programs, also located at Glendale Secondary School.

For more information about this program download and review the [HWDSB Audition Program Overview](#)

How to Apply

- Download and complete the application package [HWDSB Audition Package](#)
- Or complete your [application online](#)
- Submit the completed package to: **HWDSB Tier 3 Audition-Based Program of the Arts (at Glendale Secondary School)**

PLEASE NOTE: You will be contacted regarding your individual audition.

This program can lead to a Specialist High Skills Major (SHSM) designation in Arts and Culture. Please see your Guidance Counselor for further information.

SCIENCE AND TECHNOLOGY

For school specific programing information, please visit the school websites below:

BioTech at Ancaster Secondary School:

<http://www.hwdsb.on.ca/ancasterhigh/>

Robotics at Orchard Park Secondary School:

<http://www.hwdsb.on.ca/orchardpark/students/clubs/robotics/>

SOCIAL JUSTICE

Global Citizenship at Dundas Valley Secondary School:

<http://www.hwdsb.on.ca/dundasvalley/>

Connexions at Waterdown Secondary School:

<http://www.hwdsb.on.ca/waterdown/>

INTERNATIONAL BACCALAUREATE DIPLOMA PROGRAMME

Offered at **Ancaster** and **Westdale** Secondary Schools

The International Baccalaureate (IB) Diploma Program is a challenging two-year curriculum, primarily aimed at students aged 16 to 19. It leads to a qualification that is widely recognized by the world's leading universities. Students graduate with both the Ontario Secondary School Diploma and the International Baccalaureate Diploma.

The IB program aims to do the following:

- Prepare students for a successful transition to post-secondary school;
- Increase awareness of their role in becoming a global citizen;
- Learn and grow as a student in their self-awareness, their ability to ask challenging questions, and to develop as a leader outside of the classroom.

WHAT IS THE INTERNATIONAL BACCALAUREATE DIPLOMA PROGRAMME?

The International Baccalaureate (IB) Diploma Programme is a world-renowned pre-university course of studies, offered during the last two years of secondary school. Students graduate from this international programme with the Ontario Secondary School Diploma and the International Baccalaureate Diploma, which is recognized worldwide. French Immersion students are also accommodated within this programme.

Although the IB Programme officially begins in Grade 11, students intending to take part must take specific courses in Grades 9 and 10. There are also specific activities in Grades 9 and 10 to prepare students for the demands of the IB Program. Please see the IB coordinator at the school for more detail.

The International School of Geneva, Switzerland first conceived the IB Programme in the early 1960s. Its comprehensive curriculum strives to:

- Prepare highly motivated students for university entrance, nationally and internationally.
- Provide a curriculum, which will challenge the whole student beyond the traditional realm of the high school experience with a view to developing “global citizens”.

To this end, the International Baccalaureate Organization is committed to the following Mission Statement:

The International Baccalaureate Organization aims to develop inquiring, knowledgeable and caring young people who help to create a better and more peaceful world through intercultural understanding and respect.

All diploma candidates are required to engage in the study of languages, sciences, mathematics, and humanities. This broad programme is a deliberate compromise between the specialization desired in some countries and the emphasis of breadth often preferred by others. Students will learn how to learn, to analyze, and to reach informed conclusions about other people, their culture, and the scientific forces of the environment.

THE IB DIPLOMA

The structure of the programme is best represented as a hexagon. A student's course of studies consists of at least one subject from each of the six groups:

Three of the subjects are taken at the “Higher Level” (HL), where each is equivalent to a maximum of three senior OSSD credits. The other three subjects are taken at the “Standard Level” (SL), where each is equivalent to a maximum of two senior OSSD credits.

In addition to the six academic subjects, students complete “Theory of Knowledge” (TOK), an interdisciplinary course designed to stimulate critical reflection and develop a coherent approach to learning which transcends and unifies the academic subjects and encourages appreciation of other cultural perspectives.

“Creativity, Action, Service,” known by its acronym “CAS”, is a fundamental and unique part of the diploma curriculum. Through a minimum of 150 hours of balanced extracurricular involvements, students learn to appreciate the importance of life outside the world of scholarship. CAS provides a counter-balance to the academic self-absorption some might

feel in a demanding school programme. Through learning to work cooperatively with others, and through encouraging students to reach beyond themselves and their studies, CAS helps to educate the “whole person” and fosters a more compassionate citizenry.

Students are required to undertake original research and write an “Extended Essay” (EE) of some 4000 words. This project offers the opportunity to investigate a topic of special interest and acquaints the student with the kinds of independent research and writing skills expected in university. The topic is usually associated with some aspect of the student’s own course of study and personal interest.

For more information, please visit the websites below:

Ancaster: <http://www.hwdsb.on.ca/ancasterhigh/student-services/international-baccalaureate/>

Westdale: <http://www.hwdsb.on.ca/westdale/>

FRENCH IMMERSION PROGRAM AT SHERWOOD and WESTDALE SECONDARY

The French Immersion program helps students to achieve the educational goals set forth by Hamilton-Wentworth District School Board and the Ontario Ministry of Education, and, at the same time, to develop an ability in French at a level that permits students to:

- Use French to communicate and interact effectively in a variety of social settings;
- Learn about Canada and its two official languages and cultures;
- Appreciate and acknowledge how the global community is connected;
- Be responsible for their own learning, as they work independently and in groups;
- Use effective language learning strategies; and
- Become lifelong language learners for personal growth and for active participation as world citizens

In order to achieve a Certificat d’Immersion, students must complete 10 course, including the following Immersion French courses:

FIF1D11 FRENCH IMMERSION GRADE 9, ACADEMIC
FRANCAIS ACADEMIC - REQUIRED (WESTDALE, SHERWOOD)

FIF1P11 FRENCH IMMERSION GRADE 9, APPLIED
FRANCAIS APPLIED - REQUIRED (WESTDALE, SHERWOOD)

FIF2D11 FRENCH IMMERSION GRADE 10, ACADEMIC
FRANCAIS ACADEMIC - REQUIRED (WESTDALE, SHERWOOD)

FIF3U11 FRENCH IMMERSION GRADE 11, UNIVERSITY PREP
FRANCAIS UNIVERSITY - REQUIRED (WESTDALE, SHERWOOD)

FIF3O11 FRENCH IMMERSION GRADE 11, OPEN
FRANCAIS OPEN - REQUIRED (WESTDALE, SHERWOOD)

FIF4U11 FRENCH IMMERSION GRADE 12, UNIVERSITY PREP
FRANCAIS UNIVERSITY - REQUIRED (WESTDALE, SHERWOOD)

FIF4O11 FRENCH IMMERSION GRADE 12, OPEN
FRANCAIS OPEN - REQUIRED (WESTDALE, SHERWOOD)

Please see the French Immersion Course Descriptions for more information.

Plus six additional Immersion courses from the following list:

ADA1O11 GRADE 9 ART DRAMATIQUE

(see ADA1O1, DRAMATIC ARTS) (WESTDALE)

CGC1D1I GRADE 9 GEOGRAPHIE DU CANADA, ACADEMIC
(see CGC1D1, CANADIAN & WORLD STUDIES) (WESTDALE, SHERWOOD)

MPM1D1I GRADE 9 MATHEMATIQUES, ACADEMIC
(see MPM1D1, MATHEMATICS) (WESTDALE, SHERWOOD)

SNC1D1I GRADE 9 SCIENCES, ACADEMIC
(see SNC1D1, SCIENCE) (WESTDALE, SHERWOOD)

AVI2O1I GRADE 10 ARTS VISUELS
(see AVI2O1, VISUAL ARTS) (WESTDALE)

CHC2D1I GRADE 10 HISTOIRE DU CANADA, ACADEMIC
(see CHC2D1, CANADIAN & WORLD STUDIES) (WESTDALE, SHERWOOD)

CHV2O3I GRADE 10 EDUCATION A LA CITOYENNETE/GLC2O3I GRADE 10 EXPLORATION DE CARRIERE,
COURS OVERT (see CHV2O3, CIVICS and GLC2O3, CAREER STUDIES) (WESTDALE, SHERWOOD)

HIF1O/2O GRADE 10 VIE PERSONNELLE ET FAMILIALE, OPEN
(see HIF1O/2O, SOCIAL STUDIES AND HUMANITIES) (SHERWOOD)

MPM2D1I GRADE 10 MATHEMATIQUES, ACADEMIC
(see MPM2D1, MATHEMATICS) (WESTDALE, SHERWOOD)

SNC2D1I GRADE 10 SCIENCES, ACADEMIC
(see SNC2D1, SCIENCE) (WESTDALE, SHERWOOD)

BDI3C1I GRADE 11 INTRODUCTION A L'ENTREPRENEURIAT, COLLEGE
(see BDI3C1, INTRODUCTION TO ENTREPRENEURIAL STUDIES) (WESTDALE)

HSP3M1I GRADE 11 INTRODUCTION A LA PSYCHOLOGIE, LA SOCIOLOGIE ET L'ANTHROPOLOGIE,
UNIVERSITY/COLLEGE
(see HSP3M1, INTRODUCTION TO PSYCHOLOGY, SOCIOLOGY AND ANTHROPOLOGY) (WESTDALE)

PPL3O1I GRADE 11 L'EDUCATION DE VIE SAIN ET ACTIF, OPEN
(see PPL3O1, HEALTHY ACTIVE LIVING EDUCATION) (WESTDALE)

EWC4UI RÉDACTION ÉCRITE
(see EWC4U WRITERS' CRAFT) (WESTDALE)

Students may also gain credits by participating in a cooperative education placement in an Immersion setting. Any student wishing to work towards a French Immersion certificate should plan the best way to complete a total of 10 Immersion courses across four years of secondary school, including four Immersion Courses (FIF1D1I/FIF1P1I, FIF2D1I, FIF3U1I/FIF3O1I, AND FIF4U1I/FIF4O1I), plus six (6) additional French Immersion Courses from the list above.

Prerequisite: Elementary French Immersion 3800 hours

For more information regarding our French Immersion programming, please visit the following websites:

<http://www.hwdsb.on.ca/elementary/programs/french-immersion/>

<http://www.hwdsb.on.ca/sherwood/>

<http://www.hwdsb.on.ca/westdale/>